

DIGITAL VIDEO CAMCORDER
Instruction Manual

ENGLISH

E

CAMÉSCOPE ET LECTEUR VIDEO NUMÉRIQUES
Mode d'emploi

FRANÇAIS

F

VIDEOCÁMARA Y GRABADORA DIGITAL
Manual de Instrucciones

ESPAÑOL

Es

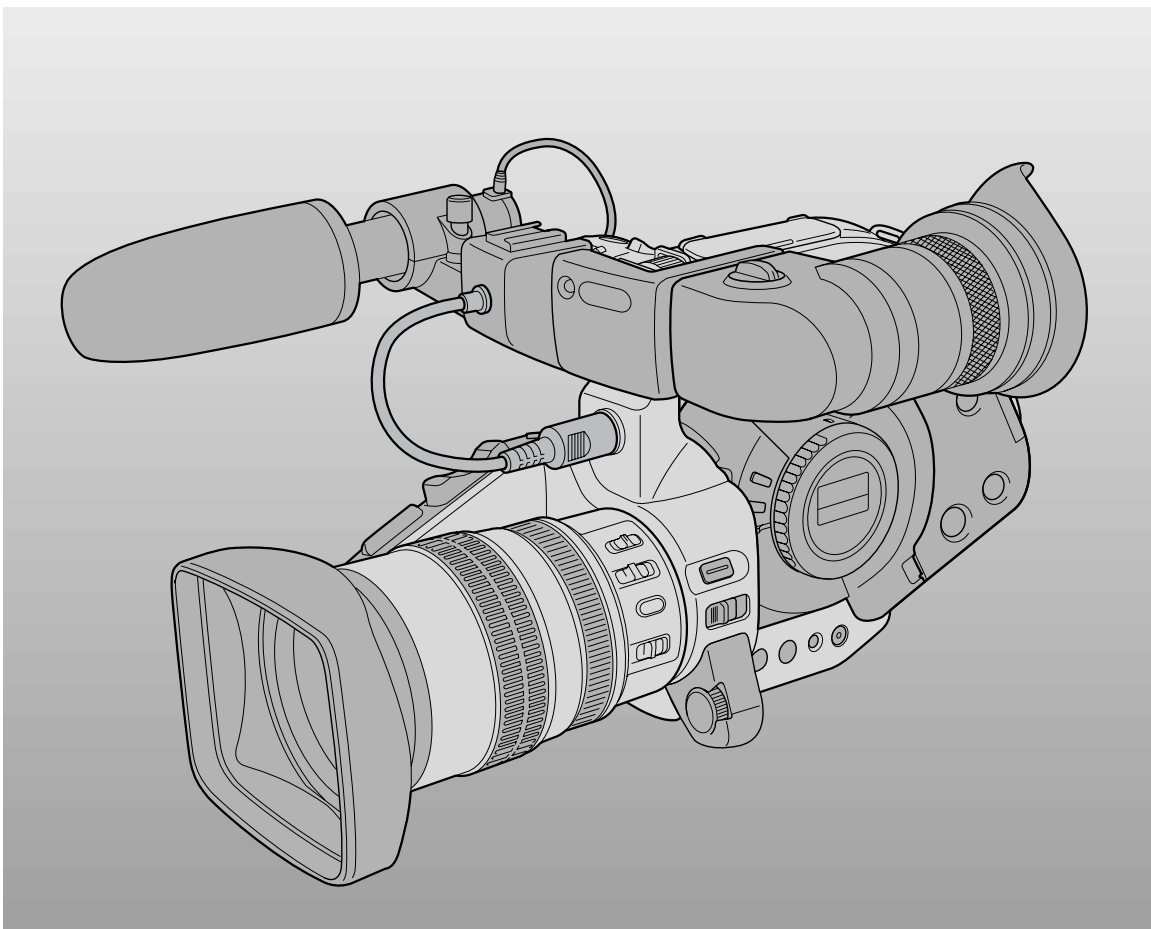

Canon
XL1
A (NTSC)

Mini **DV** Digital
Video
Cassette

Important Usage Instructions

E

WARNING:



TO REDUCE THE RISK OF FIRE OR ELECTRIC SHOCK, DO NOT EXPOSE THIS PRODUCT TO RAIN OR MOISTURE.

WARNING:



TO REDUCE THE RISK OF ELECTRIC SHOCK AND TO REDUCE ANNOYING INTERFERENCE, USE THE RECOMMENDED ACCESSORIES ONLY.

COPYRIGHT WARNING:

Unauthorized recording of copyrighted materials may infringe on the rights of copyright owners and be contrary to copyright laws.

Digital Video Camcorder, XL1

This device complies with Part 15 of the FCC Rules. Operation is subject to the following two conditions: (1) This device may not cause harmful interference, and (2) this device must accept any interference received, including interference that may cause undesired operation.

Note: This equipment has been tested and found to comply with the limits for class B digital device, pursuant to Part 15 of the FCC Rules. These limits are designed to provide reasonable protection against harmful interference in a residential installation. This equipment generates, uses and can radiate radio frequency energy and, if not installed and used in accordance with the instructions, may cause harmful interference to radio communications. However, there is no guarantee that interference will not occur in a particular installation. If this equipment does cause harmful interference to radio or television reception, which can be determined by turning the equipment off and on, the user is encouraged to try to correct the interference by one or more of the following measures:

- Reorient or relocate the receiving antenna.
- Increase the separation between the equipment and receiver.
- Connect the equipment into an outlet on a circuit different from that to which the receiver is connected.
- Consult the dealer or an experienced radio/TV technician for help.

Use of shielded cable is required to comply with class B limits in Subpart B of Part 15 of FCC Rules.

Do not make any changes or modifications to the equipment unless otherwise specified in the manual.

If such changes or modifications should be made, you could be required to stop operation of the equipment.

Canon U.S.A. Inc.

One Canon Plaza, Lake Success, NY 11042, U.S.A.

Tel No. (516)328-5600

Introduction

Important Warning



CAUTION:

TO REDUCE THE RISK OF ELECTRIC SHOCK, DO NOT REMOVE COVER (OR BACK). NO USER SERVICEABLE PARTS INSIDE. REFER SERVICING TO QUALIFIED SERVICE PERSONNEL.



The lightning flash with arrowhead symbol, within an equilateral triangle, is intended to alert the user to the presence of uninsulated "dangerous voltage" within the product's enclosure, that may be of sufficient magnitude to constitute a risk of electric shock to persons.



The exclamation point, within an equilateral triangle, is intended to alert the user to the presence of important operating and maintenance (servicing) instructions in the literature accompanying the product.

IMPORTANT SAFETY INSTRUCTIONS

In these safety instructions the word “product” refers to the Canon Digital Video Camcorder DM-XL1A and all its accessories.

1. Read Instructions — All the safety and operating instructions should be read before the product is operated.
2. Retain Instructions — The safety and operating instructions should be retained for future reference.
3. Heed Warnings — All warnings on the product and in the operating instructions should be adhered to.
4. Follow Instructions — All operating and maintenance instructions should be followed.
5. Cleaning — Unplug this product from the wall outlet before cleaning. Do not use liquid or aerosol cleaners. The product should be cleaned only as recommended in this manual.
6. Accessories — Do not use accessories not recommended in this manual as they may be hazardous.
7. Avoid magnetic or electric fields — Do not use the camera close to TV transmitters, portable communication devices or other sources of electric or magnetic radiation. They may cause picture interference, or permanently damage the camera.
8. Water and Moisture — Hazard of electric shock — Do not use this product near water or in rainy/moist situations.
9. Placing or Moving — Do not place on an unstable cart, stand, tripod, bracket or table. The product may fall, causing serious injury to a child or adult, and serious damage to the product. A product and cart combination should be moved with care. Quick stops, excessive force, and uneven surfaces may cause the product and cart combination to overturn.
10. Power Sources — The CA-900A/CA-910A Compact Power Adapter should be operated only from the type of power source indicated on the marking label. If you are not sure of the type of power supply to your home, consult your product dealer or local power company. Regarding other power sources such as battery power, refer to instructions in this manual.
11. Polarization — The CA-900A/CA-910A Compact Power Adapter is equipped with a polarized 2-prong plug (a plug having one blade wider than the other). The 2-prong polarized plug will fit into the power outlet only one way. This is a safety feature. If you are unable to insert the plug fully into the outlet, try reversing the plug. If the plug still fails to fit, contact your electrician to replace your obsolete outlet. Do not defeat the safety purpose of the polarized plug.



12. Power Cord Protection — Power cords should be routed so that they are not likely to be walked on or pinched by items placed upon or against them. Pay particular attention to plugs and the point from which the cords exit the product.
13. Outdoor Antenna Grounding — If an outside antenna is connected to the product, be sure the antenna is grounded so as to provide some protection against voltage surges and built-up static charges. Section 810 of the National Electrical Code, ANSI / NFPA No. 70—1984, provides information with respect to proper grounding of the mast and supporting structure, grounding of the lead-in wire to an antenna discharge unit, size of grounding conductors, location of antenna discharge unit, connection to grounding electrodes, and requirements for the grounding electrode. See figure 1.

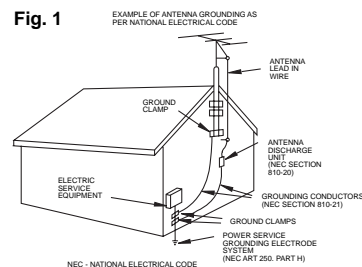

14. Lightning — For added protection of this product during a lightning storm, or when it is left unattended and unused for long periods of time, disconnect it from the wall outlet and disconnect the antenna. This will prevent damage to the product due to lightning and power-line surges.
15. Power Lines — An outside antenna system should not be located in the vicinity of overhead power lines or other electric light or power circuits, or where it can fall into such power lines or circuits. When installing an outside antenna system, extreme care should be taken to keep from touching such power lines or circuits as contact with them might be fatal.
16. Overloading — Do not overload wall outlets and extension cords as this can result in a risk of fire or electric shock.
17. Objects and Liquid Entry — Never push objects of any kind into this product through openings as they may touch dangerous voltage points or short out parts that could result in a fire or electric shock. Be careful not to spill liquid of any kind onto the product.
18. Servicing — Do not attempt to service this product yourself as opening or removing covers may expose you to dangerous voltage or other hazards. Refer all servicing to qualified service personnel.

19. **Damage Requiring Service** — Disconnect this product from the wall outlet and all power sources including battery, and refer servicing to qualified service personnel under the following conditions:
 - a. When the power-supply cord or plug is damaged.
 - b. If any liquid has been spilled onto, or objects have fallen into, the product.
 - c. If the product has been exposed to rain or water.
 - d. If the product does not operate normally even if you follow the operating instructions. Adjust only those controls that are covered by the operation instructions. Improper adjustment of other controls may result in damage and will often require extensive work by a qualified technician to restore the product to its normal operation.
 - e. If the product has been dropped or the cabinet has been damaged.
 - f. When the product exhibits a distinct change in performance. This indicates a need for service.
20. **Replacement Parts** — When replacement parts are required, be sure the service technician has used replacement parts that are specified by Canon or that have the same characteristics as the original part. Unauthorized substitutions may result in fire, electric shock or other hazards.
21. **Safety Check** — Upon completion of any service or repairs to this product, ask the service technician to perform safety checks to determine that the product is in safe operating order.

Contents

Introduction

Important Usage Instructions	2
IMPORTANT SAFETY INSTRUCTIONS	3
Thank you for choosing a Canon	6
Introducing the XL1	7

Preparation

Mounting and Removing XL Lenses	8
Adjusting the Viewfinder Unit	10
Attaching the External Microphone	12
Powering the XL1	13
Loading a Cassette	15
Supporting the Camera	17
Selecting from the Menus	18
Using the Wireless Controller/Tally Lamps	20
Setting the Date and Time	22

Recording

Basic Recording	23
Zooming (for Zoom Lenses)	25
Turning the SuperRange Optical Image Stabilizer On/Off	27
Using the ND Filter (for appropriate lenses)	28
Taking Still Pictures (Photo Mode)	29
Choosing the Movie Mode (Normal/Frame)	30
Searching and Reviewing While Recording	31
Using the Various Recording Programs	32
Activating the Slow Shutter	35
Selecting the Audio Mode	36
Setting the Audio Input — Two Channel Recording	37
Setting the Audio Input — Four Channel Recording	38
Making a Sound Check	39
Fading In and Out Between Scenes	40
Setting the Self-Timer	42
Using a Canon Speedlite for Flash Photography (optional)	43

~ When Making Manual Adjustments ...~

Adjusting the Focus	44
Adjusting the Exposure	45
Using AE Shift	46
Using the Zebra Pattern	47
Adjusting the Gain	48
Adjusting the White Balance	49

Playback

Playing back a Cassette	51
Displaying Data Code	54
Searching Through Your Recorded “Photos” (Photo Search)	55
Connections for Playback on a TV Screen	56
Editing to a VCR	57
DV Dubbing (DV terminal conforming to IEEE1394)	58
Selecting the Audio Output	60

Additional Information

Notes on Using the Batteries	62
Camera Holding Styles	65
Maintenance	66
Troubleshooting	69
The XL1 System Diagram	72
Optional Accessories	73
Finding Your Way Around the XL1	76
Screen Displays	80
Specifications	85
Index	86

E

Introduction

The serial number of this product may be found on the bottom of the camera. No others have the same serial number as yours. You should record the number and other vital information here and retain this book as a permanent record of your purchase to aid identification in case of theft.

Date of Purchase
Dealer Purchased From
Dealer Address
Dealer Phone No.
Model Name XL1
Serial No.

Thank you for choosing a Canon

E

First, we'd like to thank you for purchasing this Canon camcorder. Its advanced technology makes it very easy to use — you will soon be making high-quality videos which will give you pleasure for years to come.







For quick reference (in addition to the contents and index) please refer to:

- Finding your way around the camcorder (p. 76)
- Screen displays (p. 80)

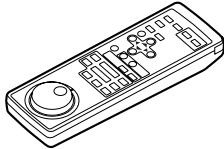
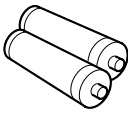
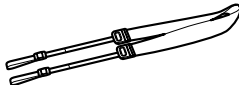
Note that capital letters are used to refer to settings displayed in the menus and buttons labelled on the camcorder itself e.g. Press the EJECT button.

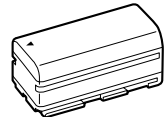
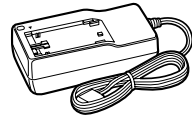
The XL1 is supplied with the following accessories:

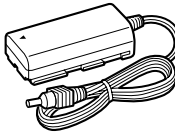
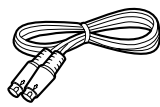
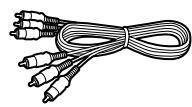
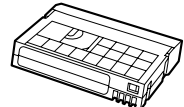
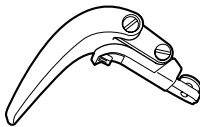
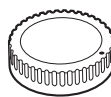
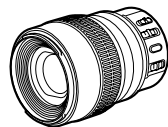
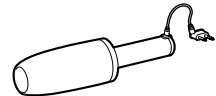
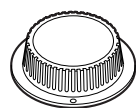
Introduction

<p>WL-D2000 Wireless Controller</p> 	<p>Two AAA batteries</p> 	<p>SS-1000 Shoulder Strap</p> 	<p>Lens cap</p> 	<p>BP-927 Battery Pack</p> 
<p>CA-900/CA-910 Compact Power Adapter</p> 	<p>Lithium button battery</p> 	<p>DC-900 DC Coupler</p> 	<p>S-150 S-video Cable</p> 	<p>STV-150 Stereo Video Cable</p> 
<p>Digital Video Cassette</p> 	<p>SP-100 Shoulder pad</p> 	<p>Body cap</p> 	<p>16× Zoom Lens (with soft case)</p> 	<p>Stereo microphone</p> 
<p>Dust cap</p> 	<p>Lens hood</p> 			

Introducing the XL1

Digital Video

XL1 conforms to the new digital video ^{MiniDV} standard to give you outstanding picture quality. It is fitted with a DV terminal for digital-to-digital dubbing (IEEE 1394 standard).

Interchangeable Lens System

A super-flexible system with an unbeatable range. XL1 maximizes your options with a focal range of between 24 and 2160 mm (35mm camera equivalents), made possible through the use of XL and EF lenses.

EF Adapter (optional)

A valuable accessory is the EF Adapter that fits onto the XL1 to allow you to use Canon EF lenses (that have manual focusing). The difference in size between the XL1's CCD and 35 mm film means that the effective focal length of the EF lens is multiplied by 7.2x. A 300 mm lens, for example, can be transformed into an incredible 2,160 mm super telephoto.

3CCD System with Pixel Shift Technology

Superb picture quality results from using a larger light capturing area for each pixel (and fewer pixels) to give higher sensitivity, higher SN ratio and a greater dynamic range, and then horizontally shifting the green CCD to ensure high image resolution. In addition, you can now get stunningly clear still pictures from video action.

SuperRange Optical Image Stabilizer

Canon's latest advances in stabilization technology give you steadier images than ever before, even at the furthest reaches of the zoom range. Essential to this is a new feedback system, which boosts suppression performance for low frequency vibration.

High Performance Lenses

XL lenses resolve over 600 TV lines to give an extraordinarily sharp image. By exceeding the DV standard of 530 TV lines, The Canon lens delivers greater visual "sharpness" through its higher sensitivity in the all important 100 to 250 TV line resolution area.

16x (32x Digital) Zoom Lens as Standard

From wide-angle to 16x telephoto — with unparalleled optical quality. The digital zoom doubles this magnification for even more dramatic results.

PCM Digital Audio

Offers you stunning digital sound — 16-bit for highest quality sound, and two 12-bit modes for the playback of audio-dubbed cassettes, or simultaneous recording (and independent output) of 4 audio channels.

Multi-View Finder

Slide the professional style (180,000 pixel) color viewfinder across to the position that suits your individual line of sight — whether you use your left or right eye. What's more, you can set the viewpoint from close-range to open-range at the flick of a switch.

Manual Control

Choose to operate the XL1 using the Manual recording program to access the complete set of manual functions, for exceptional creative freedom.

Shoulder Supported Design

The slim line styling of the XL1 allows you to support the camera against the front of your shoulder when recording. Alternatively, operate the camera using the top recording controls located on the handle — which functions as a second gripping position for low-angle shooting.

Magnesium Alloy Casing

The XL1 is cast from magnesium alloy to provide heavy-duty protection from a lightweight body.

E

Mounting and Removing XL Lenses

E

Any lens bearing the **XL** mark can be used with this camcorder.

Mounting the lens

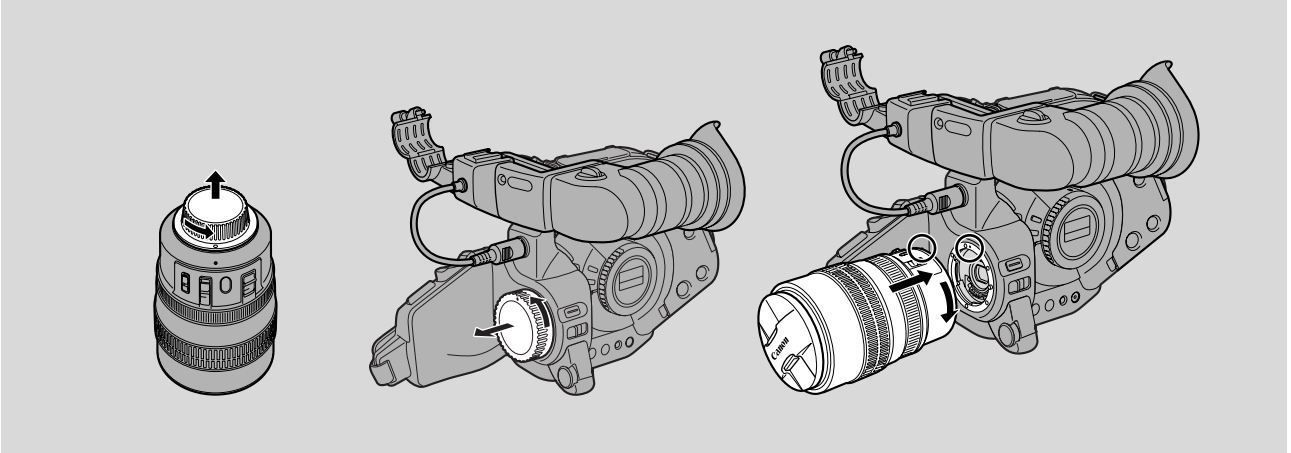

1. Remove the dust cap from the lens and the body cap from the camcorder.
2. Align the red dot on the camera body with the mount positioning point (the red dot) on the lens, then turn the lens clockwise until it clicks and locks into place.

Preparation

Removing the lens

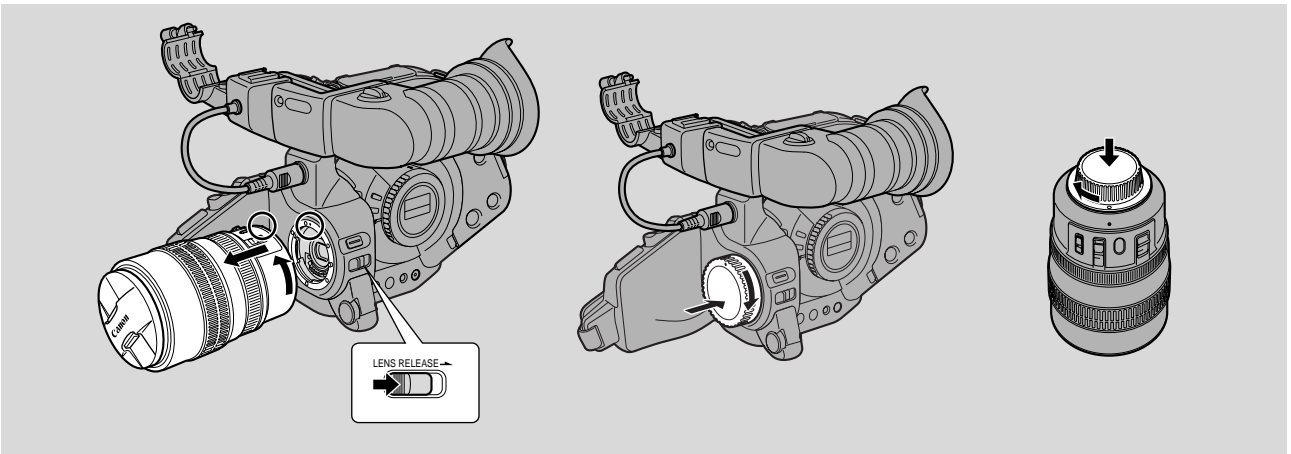

1. Slide and hold the **LENS RELEASE** switch and turn the lens counter-clockwise until it stops. Then, remove the lens from the camera body.
2. When you are not using the lens or camera, be sure to replace the dust cap and body cap.

Attaching the Lens Hood

E

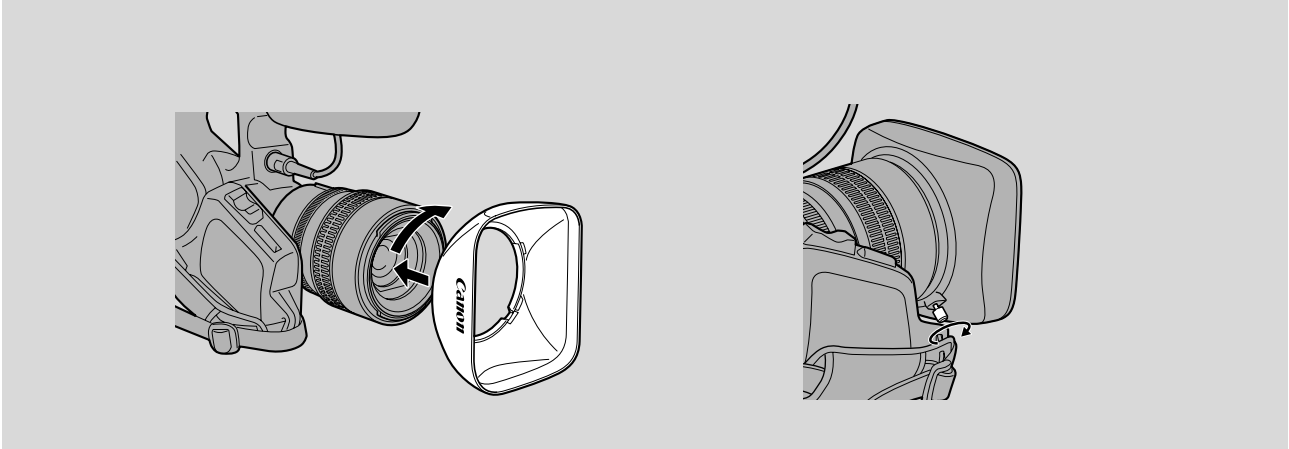

1. Remove the lens cap.
2. Align the hood with the lens lengthways, and the Canon logo facing to the left.
3. Twist it 90° into position (clockwise), so that the Canon logo is to the top.
 - You do not need to assert any pressure — screw the hood lightly into place.
4. Finally, tighten the locking screw.
 - To remove, reverse the above procedure.

Since the lens hood cuts stray light that may cause flare and ghost images and protects the lens, be sure to attach the hood when you are recording.

Lens settings

There are four functions which can only be adjusted using controls on the lens:

- Optical Image stabilizer (p. 27)
- ND Filter (p. 28)
- Push Autofocus (p. 44)
- Manual Focus (p. 44)

Notes:

- Make sure that the camera is turned off before mounting or removing the lens.
- To avoid damaging the lens or camera, place them on a table or secure surface when mounting or removing the lens.
- Use only lenses bearing the **XL** mark. You cannot use VL mount lenses with this camcorder.
- If you turn the camera on without a lens attached the caution “CHECK THE LENS” is displayed for a few seconds. “LENS” then flashes continuously in the viewfinder. Turn the camera off and mount a lens. (“LENS” also flashes if only the optional EF Adapter XL or Extender XL 1.6 × is attached.)

When the lens is removed from the camcorder, avoid contact with the exposed parts inside the camera (such as the CCD area). If such parts require cleaning, do so with a commercially available lens cleaning kit, making sure that the camera is turned off first.

Adjusting the Viewfinder Unit

E

The camera is supplied with the viewfinder unit and cable attached to the camera.

- Check that the viewfinder cable is firmly attached to the camcorder.

- Remove the protective rubber from around the locking screw.

Adjusting for left eye/right eye operation

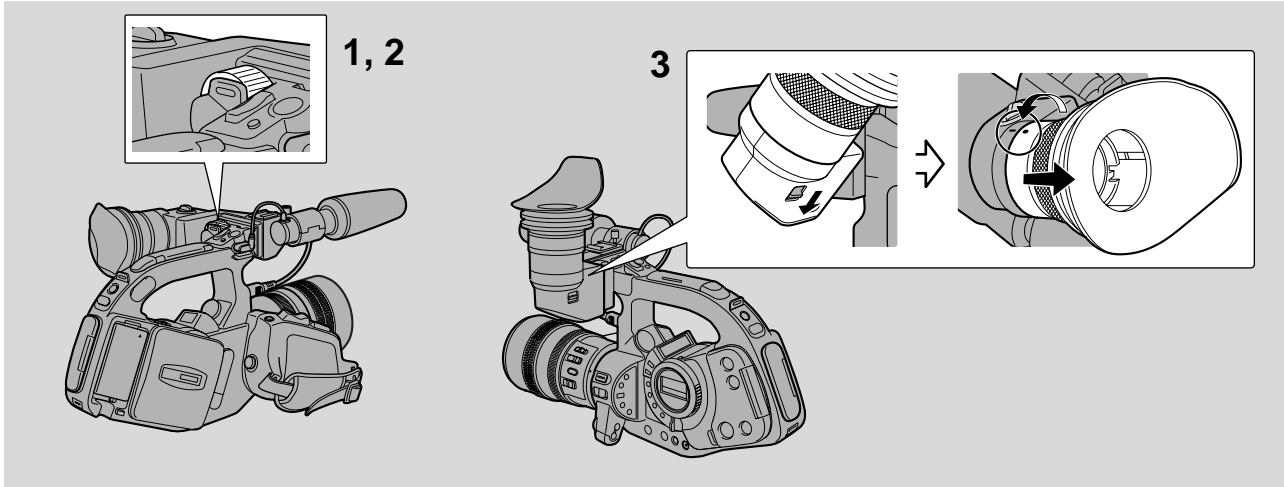

Preparation

You can slide the viewfinder unit along the bracket to a position that best suits you — for use with either the left or right eye.

1. **Loosen the locking screw and slide the unit to the position you require along the bracket.**
2. **Tighten the locking screw.**
3. **Switch the eye cup around (if necessary).**
 - Slide and hold the release lever on the underside of the viewfinder and then twist the eye cup counter-clockwise (until the mark on the eye cup lines up with the mark on the viewfinder) to allow you to remove it from the viewfinder. Replace, with the eye cup facing the opposite direction, by lining up the marks and twisting the cup clockwise until it locks into place.

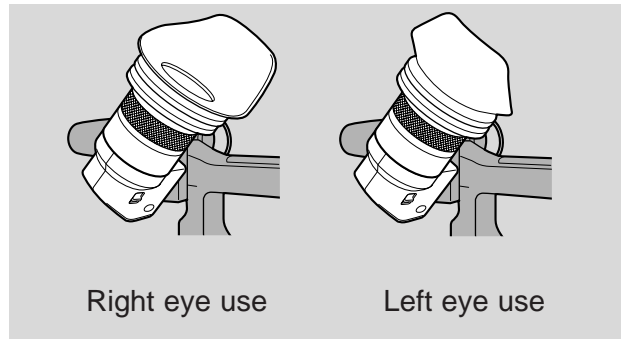

Adjusting to your viewing point

To monitor the scene with your eye near to the viewfinder turn the EYE POINT SELECT switch to NEAR. To view the scene at a distance from the viewfinder, turn the switch to FAR.

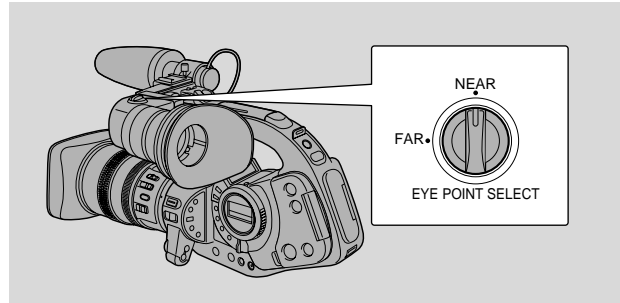

Adjusting to your eyesight

- In record pause mode, turn the viewfinder focusing ring (focusing the display between -5 and +2) to suit your eyesight.
- The viewfinder rotates through 270° to give a choice of shooting positions.

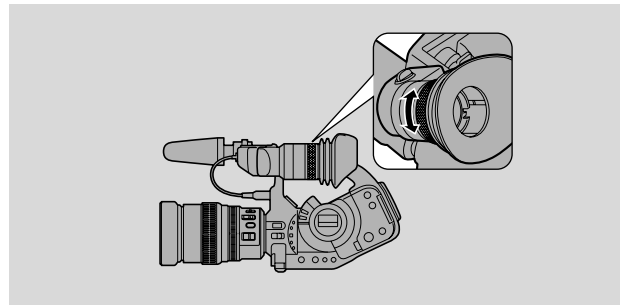

Attaching the External Microphone

E

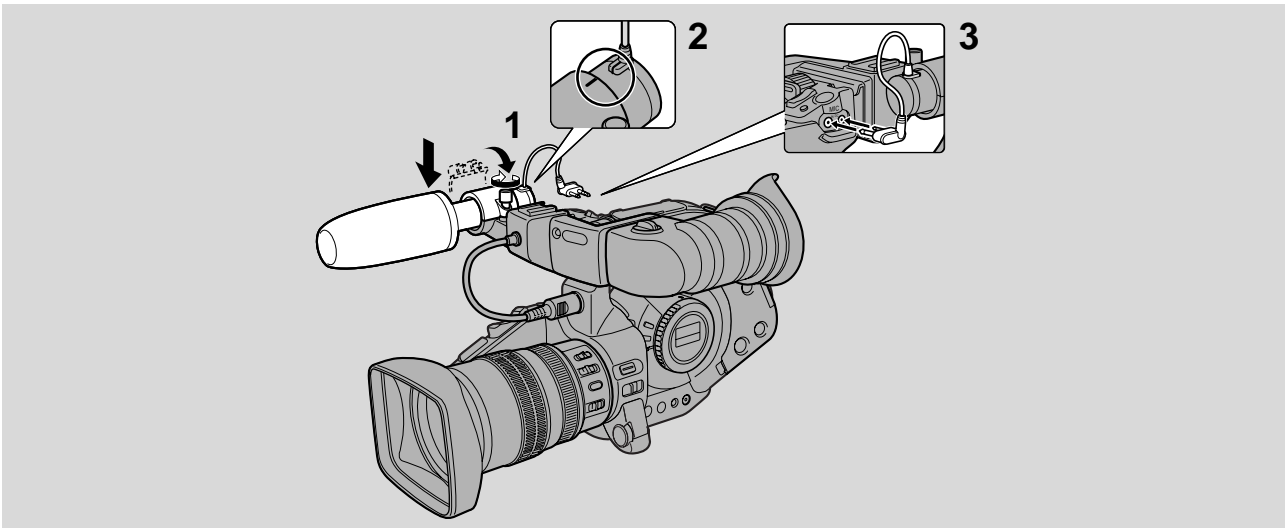

1. Loosen the microphone attachment screw on the viewfinder unit and insert the microphone into the microphone clamp.
2. Align the mark on the microphone with the mark on the clamp and tighten the screw to hold the microphone firmly in place.
3. Plug the microphone cable to the camera's MIC terminals.

Preparation

Note:

- Make sure that the camera is turned off before attaching or removing the microphone cable.

Powering the XL1

Before operating your camera, you will need to use the power adapter to:

provide power from an AC outlet
or
charge a battery pack

Notes:

- The power adapter converts current from a household power socket (100–240 V AC, 50/60 Hz) to the DC current used by your camera.
- If the adapter is used next to a TV, it may cause the TV to emit noise — move the adapter away from the TV or the antenna cable.

Connecting the camera to an AC outlet

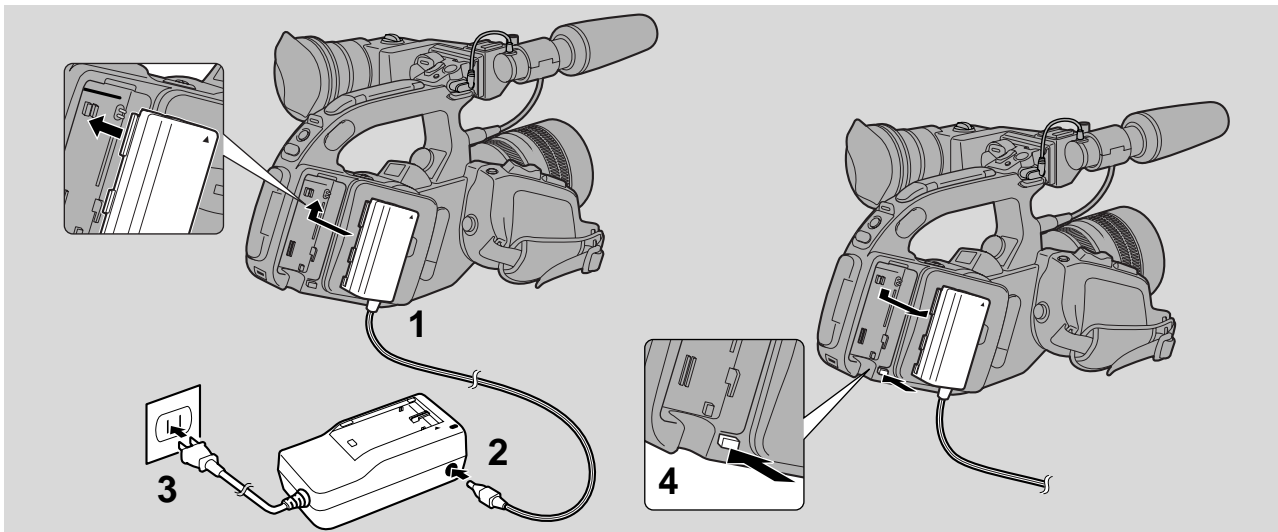

Use the power adapter and the DC coupler to provide your camera with instant power from an AC outlet.

1. Attach the DC coupler to the camera.

- Align the triangle on the DC coupler with the line on the camera.
- Slide the coupler in the direction of the arrow, until it clicks into place.

2. Connect the DC coupler to the adapter.

3. Plug the adapter into an AC outlet.

4. Detach the DC coupler after use.

- Press and hold the BATT. RELEASE button, while you slide the coupler down.
- Always turn the camera off before removing the power source.

When replacement or repair of any product including power supply is required, please return it to the nearest authorized Canon Service Center and have it repaired or replaced with the same number product or equivalent.

Charging and attaching the battery pack

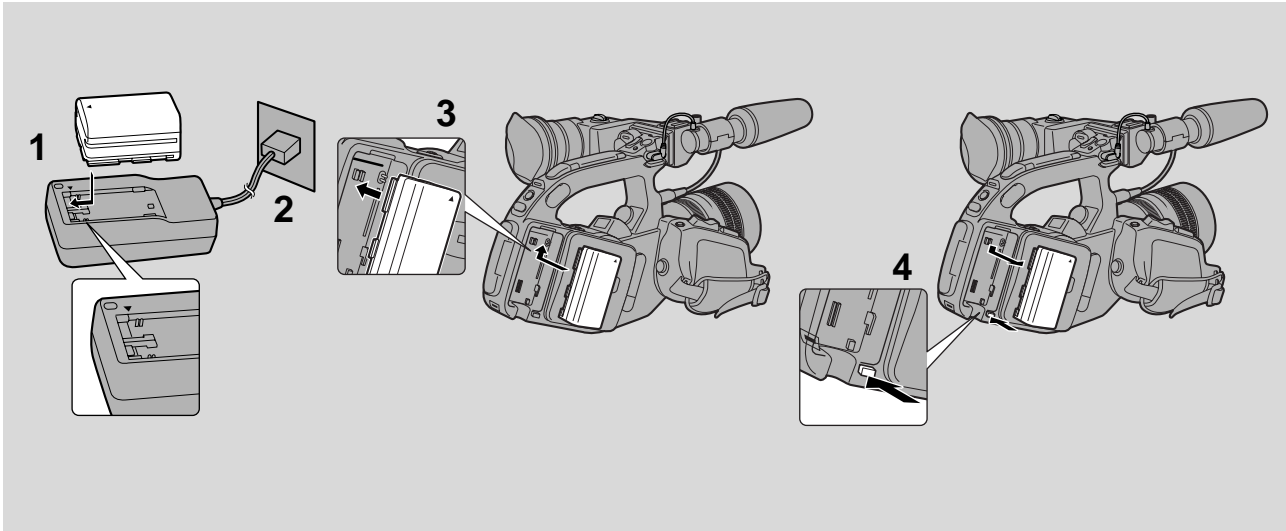

Your battery pack was partially charged before it left the factory. It should have enough power for you to check that your camera is working properly. However, you must charge the battery pack fully if you want it to power the camera for more than a few minutes.

1. Attach the battery pack to the power adapter.

- Align the triangle on the battery pack with the line on the power adapter.
- Slide the battery across until it clicks into place.
- Make sure the DC coupler is not connected.

2. Plug the adapter into an AC outlet.

- The charge indicator flashes red to show that charging is in progress. Single flashes mean that the battery pack is less than 50% charged. Double flashes mean that it is between 50% and 75% charged. Triple flashes mean that it is more than 75% charged.
- The indicator glows steadily when the battery pack is fully charged.

3. Take the battery pack off the adapter and attach it to the camera.

- Align the triangle on the battery pack with the line on the camcorder, then slide the battery up in the direction of the arrow until it clicks into place.

4. Remove the battery pack after use.

- Press and hold the BATT. RELEASE button, while you slide the battery down.
- Always turn the camera off before removing the power source.

Notes:

- You can find detailed notes for using the batteries in the “Notes on Using the Batteries” on p. 62. These notes include charging and recording times and how to install the back-up battery.
- Using the optional CH-900 Dual Battery Charger/Holder you can power the camera from two battery packs for longer continuous recording. You can exchange the battery packs independently without cutting the power to the camcorder. In addition, the CH-900 can charge two batteries consecutively when it is connected to an AC outlet.

Loading a Cassette

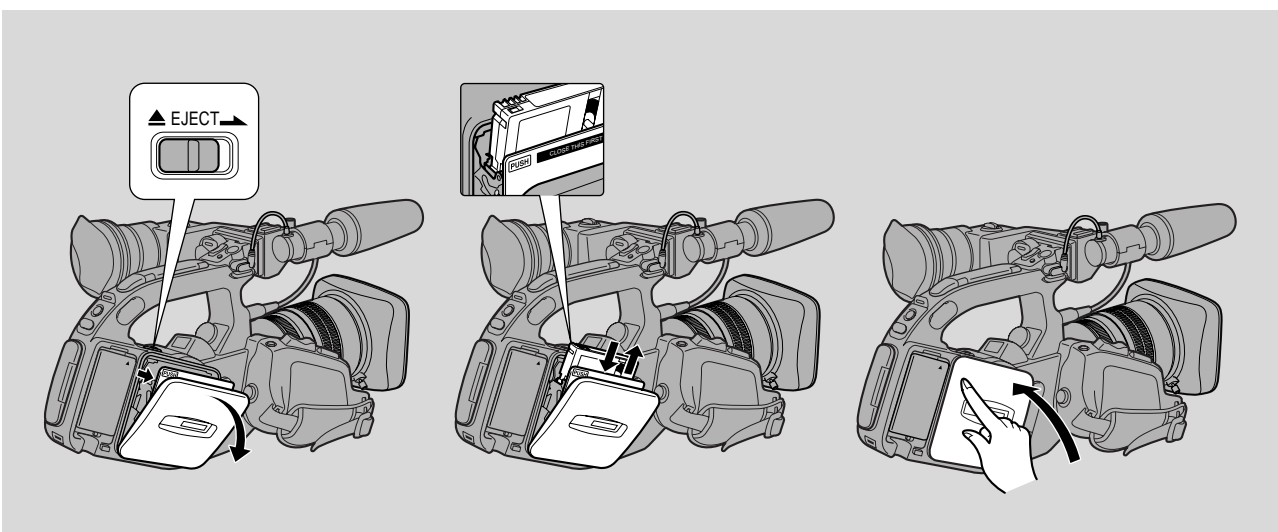

E

Use videocassettes marked with the **MiniDV** logo only.*

Loading and unloading

1. Make sure that you have inserted a power source.
2. Slide the **EJECT** ▲ button across to release the cover.
 - Wait a couple of seconds for the cassette compartment to open automatically.
3. Load or unload the cassette.
 - Insert the cassette gently with the window facing out.
 - Remove the cassette by pulling it straight out.
4. Press the **(PUSH)** mark on the compartment until it clicks.
5. Click the cover back into place.

* **MiniDV** is a trade mark.

Notes:

- After loading a cassette, use record search (p. 31) to find the point where you want to start recording.
- Do not interfere with the cassette compartment while it is opening or closing automatically, or attempt to close the cover.
- Do not leave the cassette in the camera after use — return it to its case and store it in a cool, clean, dry place.

Protecting tapes from accidental erasure

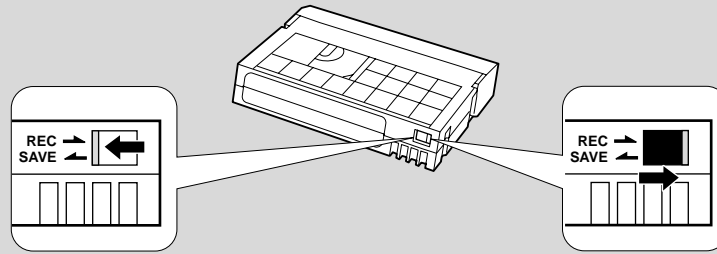

To protect your recording from accidental erasure, slide the tab on the cassette so that it exposes the hole and the red mark. (This switch position is usually labeled SAVE or ERASE OFF.)

If you load this cassette and put the camera in record pause mode (p. 23), “THE TAPE IS SET FOR ERASURE PREVENTION” is displayed for approx. 4 seconds and then the  mark flashes in the display. The camera also shows the above phrase if you accidentally press the ● (record) button with the camera switched to VCR mode.

If you want to record on the cassette again, slide the tab back so the hole is closed, and the red mark covered.

Handling cassettes

- To protect the tape heads, transfer cassettes directly from the tape case to the camcorder — do not open the tape protect cover or touch the tape itself.
- Do not use cassettes where the tape has been damaged or rejoined — they may damage the camcorder.
- Do not insert anything into the small holes on the cassette or cover them with cellophane tape.
- Handle cassettes with care — dropping them or exposing them to external shocks may cause internal damage.
- Store cassettes in the provided case, rewinding them to the start of the tape first, and then storing them upright.
- A cassette with metal plated terminals may become dirty with use, affecting information transfer. Therefore, after using a tape around ten times, be sure to clean the terminals with a cotton wool bud.

Cassette memory

You are unable to use the cassette memory function with this camcorder.

Supporting the Camera

Prepare the lens cap

- Attach/remove the lens cap as shown.

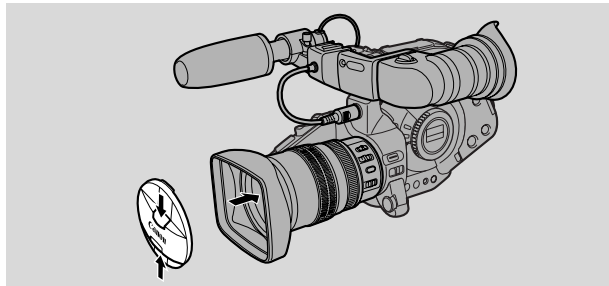

E

Attach the SP-100 shoulder pad

- For extra comfort and control, attach the shoulder pad to the camera.
- Clip the adapter unit onto the base of the camcorder and tighten the fixing screw using a coin.
- When you are not using the shoulder pad, fold it in towards the camera until it clicks into the storage position.

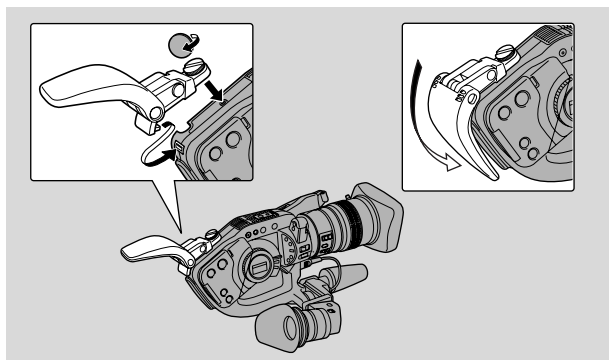

Adjust the grip belt

- Adjust the length of the grip belt strap so that you can operate the start/stop button and zoom control effectively.

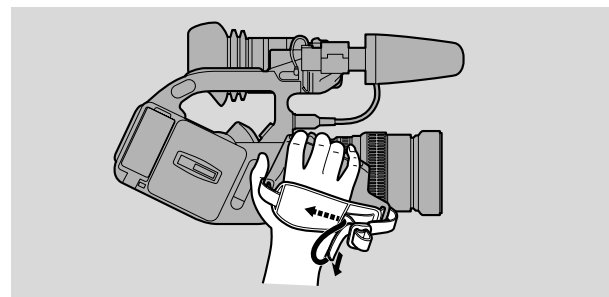

Attach the shoulder strap

- For extra security and portability, attach the shoulder strap before using the camera
- Pass the ends through the attachment bars and adjust the length as shown.

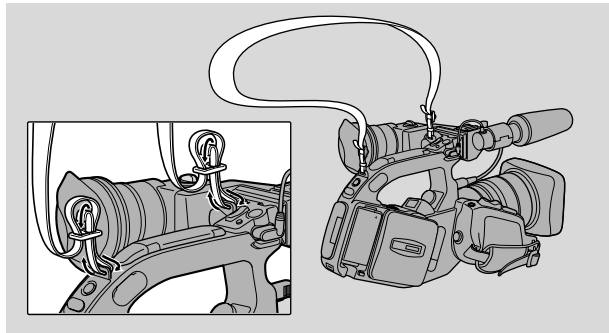

Preparation

Notes:

- Be careful not to leave the viewfinder exposed to bright sunlight, or it may damage the LCD. (The light is concentrated by the viewfinder lens.) Either turn the EYE POINT SELECT switch to the FAR setting, or change the angle of the viewfinder to move it out of direct sunlight.
- Place the camera on a table or secure surface when attaching the shoulder pad, grip belt or strap.

Selecting from the Menus

E

Many of the camera's advanced functions are selected from menus which appear in the viewfinder.

There are two main menus:

1. Camera menu (when the camera is in record pause mode: the POWER dial set to a recording program.)
2. VCR menu (when the POWER dial is set to VCR)

Camera menu (CAM. MENU)

- ① Zebra patternp. 47
- ② 16:9 effectp. 41
- ③ Movie modep. 30
- ④ Remote sensorp. 21
- ⑤ Tally lampp. 21
- ⑥ Audio modep. 36
- ⑦ Audio 1 Inputp. 37
- ⑧ Audio 2 Inputp. 38
- ⑨ Recording modep. 24
- ⑩ Date/time setp. 22

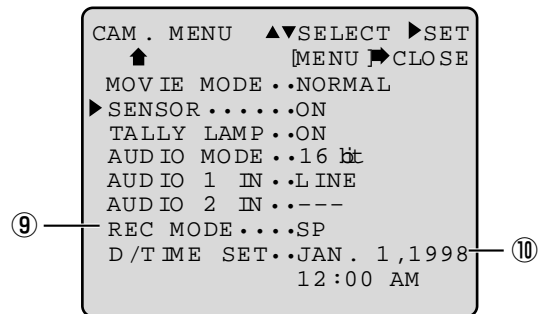
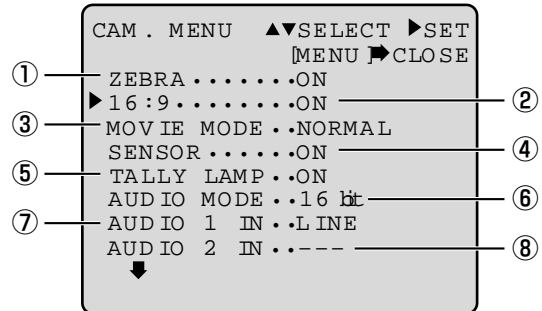

VCR menu

- ① Tally lampp. 21
- ② Remote sensorp. 21
- ③ Recording modep. 24
- ④ Mix balancep. 60
- ⑤ Output channelp. 61
- ⑥ Data codep. 54
- ⑦ Date/time selectp. 22
- ⑧ Date/time setp. 22

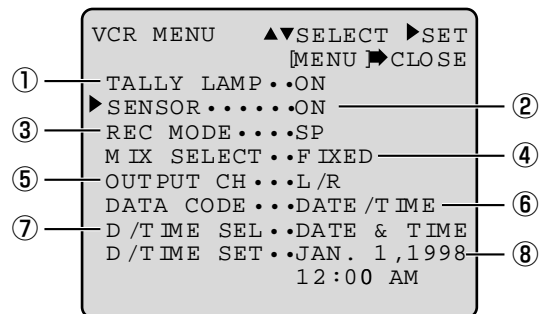

Turn to the appropriate page for a detailed explanation of each function.

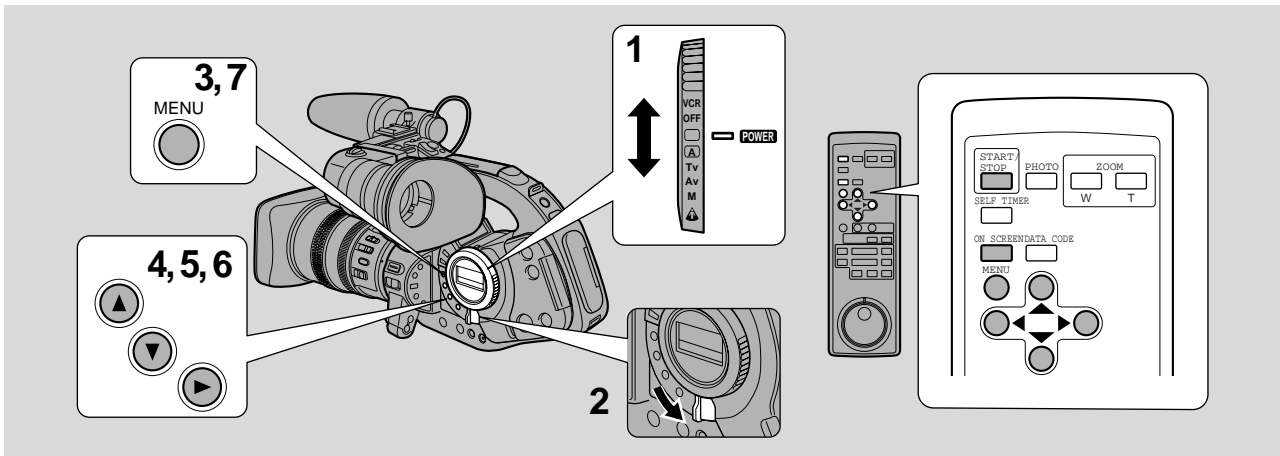

1. Turn the **POWER** dial to a recording program or to **VCR**.
2. Slide open the red cover to reveal the menu operation keys.
3. Press the **MENU** button to open the menu.
4. Press **▲** or **▼** cursor key to move the arrow up or down the display.
5. Press the **▶** cursor key to select your chosen option from the menu.
 - Your selected option remains on the screen and all other options are removed.
6. Press the **▲** or **▼** cursor keys to choose its setting.
 - You can return to the full menu by pressing the **▶** cursor key.
7. Press the **MENU** button to close the menu.
 - Close the red cover to hide the menu operation keys.

Notes:

- You can only see eight options on the screen at the same time. Pointers at the top/bottom of the screen indicate that there are more options that you can scroll through.
- You may often find it convenient to use the wireless controller to move around the menus. Press its **MENU** button to enter/leave the menu and use its cursor keys in place of those on the camera itself. (In step 6 however, use the **◀** cursor key to return to the full menu.)
- You can display the menus on a connected TV screen using the wireless controller's **ON SCREEN** button.

Using the Wireless Controller/Tally Lamps

E

The supplied wireless controller can operate the camera from a distance of up to 16 feet (5 m). Point it at either of the camera's remote sensors while you press the buttons.

The tally lamps light up to let you know that the camera is in range and responding to your commands.

There are five functions which can only be operated using the wireless controller:

- Special playback (p. 53)
- TV-screen displays (p. 80)
- Data code on/off (p. 54)
- Photo search (p. 55)
- Self-timer (p. 42)

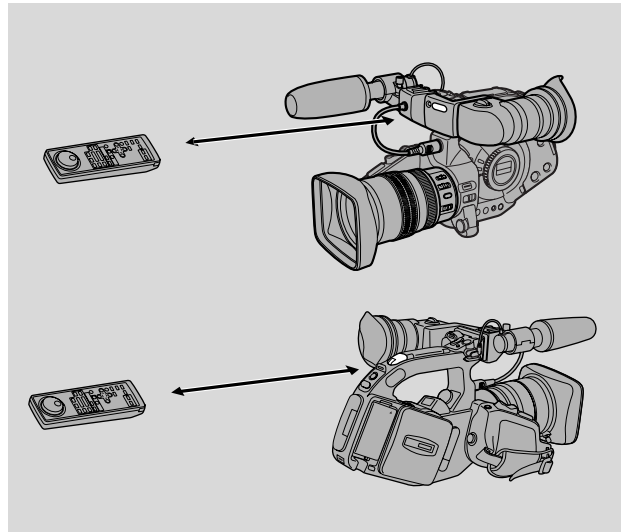

Inserting batteries

Insert two AAA batteries, following the ⊕ and ⊖ markings. Be careful not to reverse the polarity of the batteries.

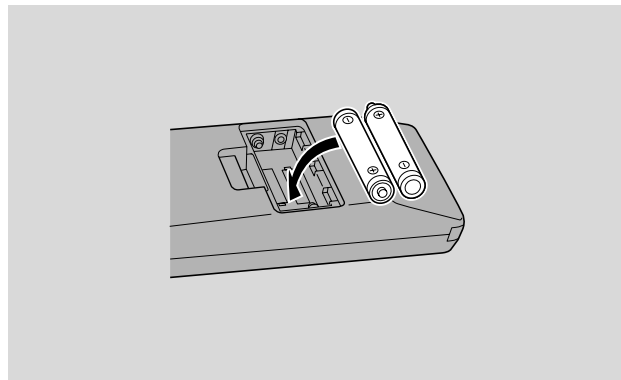

Preparation

Notes:

- When using the wireless controller in brightly lit places or outdoors, the effective range will be less.
- The camera may have difficulty picking up the remote control signals at extremely close range.
- Do not leave the controller exposed to direct sunlight, or in hot or humid places.
- When the batteries run out, replace them both together.
- Make sure the shoulder strap does not obstruct the tally sensors.

Turning off the remote sensors

The remote sensors can be turned off to prevent interference from other Canon wireless controllers being used nearby.



1. Open either the camera or the VCR menu, and point the arrow at **SENSOR**.
2. Select the **OFF** setting and close the menu.
 - **SOFF** appears in the viewfinder.

Turning off the tally lamps

The tally lamps let you know that the camera is recording. However, the flashing of the front lamp may be reflected into the lens during close-up recording, or when recording through glass.

You may therefore decide to turn them off.

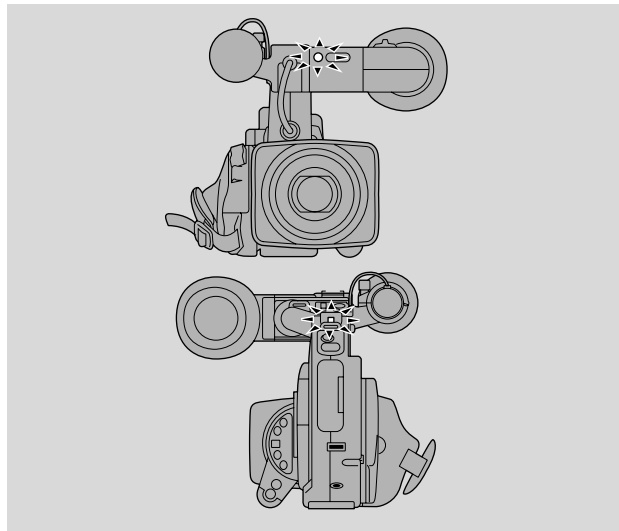

1. Open either the camera menu or the VCR menu, and point the arrow at **TALLY LAMP**.
2. Select the **OFF** setting and close the menu.
 - The tally lamps no longer flash during recording, but they will still light up when the camera receives a signal from the wireless controller.

Setting the Date and Time

E

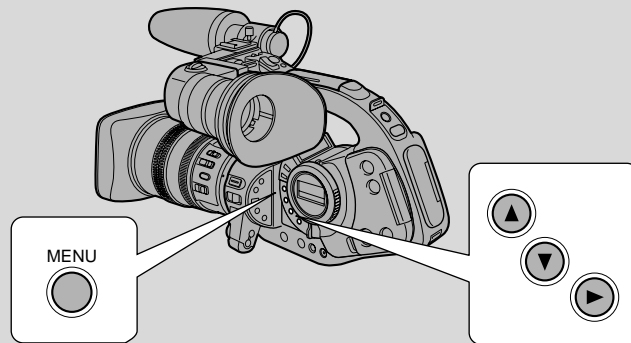

The date and/or time display forms part of the data code. You can choose to display or hide it during playback (see p. 54).

Set the date and time display when you first start using your camera. Install the backup battery before you begin (see p. 63).

Preparation

1. Turn the POWER dial to a recording program or to VCR.
2. Open the menu and select D/TIME SET.
 - The year display starts to flash in the viewfinder.
3. Press the ▲ or ▼ cursor key to change the year. Press the ► cursor key to move to another part of the display.
 - Press once to scan a year at a time. Press and hold to scan quickly.
 - Once you move from the year, the next part of the display starts flashing.
4. Set the months, days, hours, and minutes in the same way.
5. Press the MENU button when finished, and to start the clock.

- The date can be set to any year between 1997 and 2020.
- If you press the MENU button in the middle of setting the date and time the seconds are set to zero, you leave the menu, and the clock starts.
- If you press the ► cursor key after setting the minutes, the seconds are set to zero, the clock starts and you return to the full menu. (When using the remote control, use the ◀ cursor key instead. Pressing the ► cursor key returns you to the end of step 2, to let you set the date and time again from the start.)

Setting the display style



► D/TIME SEL. · DATE & TIME

1. Turn the POWER dial to VCR.
2. Open the VCR menu and select D/TIME SEL.
3. Choose between DATE, TIME and DATE & TIME.
4. Press the MENU button to close the menu.

Basic Recording

E

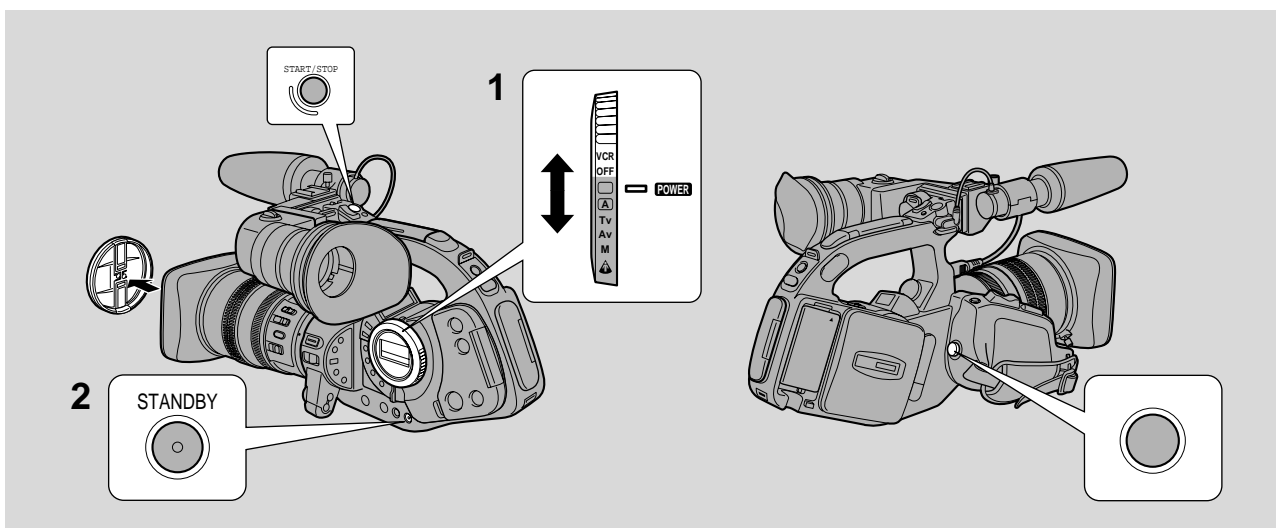

Before you start recording

- Attach a power source (p. 13).
- Load a cassette (p. 15).
- Remove the lens cap and fasten the shoulder pad (p. 17).
- Adjust the viewfinder (p. 10).
- Choose your grip — side or top (p. 65).

You may also want to install the backup battery (p. 63) in order to set the date and time display (p. 22).

To record

- 1. Turn the POWER dial to \square x.**
 - This selects the camera's Easy Recording program. It allows you to simply point and shoot without making any manual adjustments (see pp. 44-50).
 - The camera power indicator lights up red and PAUSE appears in the viewfinder — the camera is now in "record pause mode".
 - The camera will turn itself off if you leave it in record pause mode for more than about five minutes. To return to record pause mode, press and hold the STANDBY button for a few moments, or set the POWER dial to OFF and then back to a recording program.
- 2. Press the start/stop button to begin recording.**
 - There are two start/stop buttons, to give you control from both gripping positions.
 - The tally lamps flash rapidly and REC appears in the viewfinder.
- 3. Press the start/stop button again to pause recording.**
 - The camera returns to record pause mode and PAUSE reappears in the viewfinder.
 - You can stop and restart recording as often as you like by pressing the start/stop button.

Using the STANDBY button

As long as the POWER dial is set to a recording program, you can use the STANDBY button to turn the camera on and off. This makes it easy to save battery power, and prevents accidental operation of the start/stop button.

Press and hold the STANDBY button for a few moments to enter/leave standby mode. When the camera enters standby mode, ENTERING POWER STANDBY is shown in the viewfinder.

When you have finished recording

- Replace the lens cap.
- Unload the cassette.
- Set the POWER dial to OFF.
- Disconnect the power source.

Notes:

- To check that the camera is recording correctly, make a test recording first.
- Before making important recordings, clean the video heads using a Canon DVM-CL Digital Video Head Cleaning Cassette or a commercially available digital video head cleaning cassette.

Changing the recording mode (SP/LP)

You can record and play back a tape in SP (standard play) and LP (long play) modes. LP extends tape usage by 1.5 times.

To switch to LP mode, select REC MODE from the camera or VCR menu, select LP and then close the menu (for instructions on how to use the menus, refer to page 18).



▶REC MODE.....LP

Notes:

- If you record in both modes on the same tape, the picture may become distorted during playback and the time code may not be written correctly.
- When the camera is set to LP mode, pausing between recordings may produce mosaic-like noise.
- A tape recorded in LP mode on another camcorder may produce mosaic-like noise when played back on this camcorder, and vice versa.

Turning the camera recording displays ON/OFF

You can show/hide non-essential camera recording displays by pressing the EVF DISPLAY button.

Note:

- You cannot hide the time code or recording condition (REC, PAUSE etc.) displays.

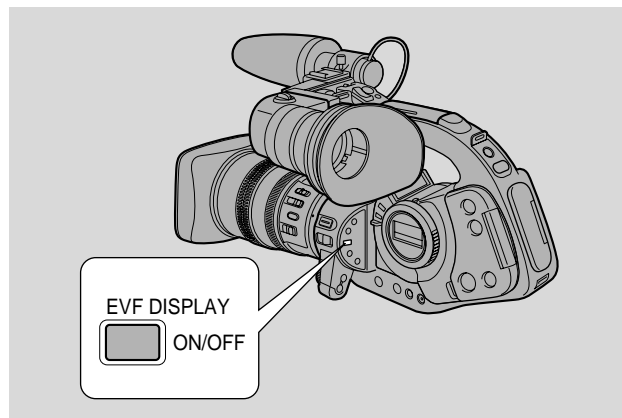

Zooming (for Zoom Lenses)

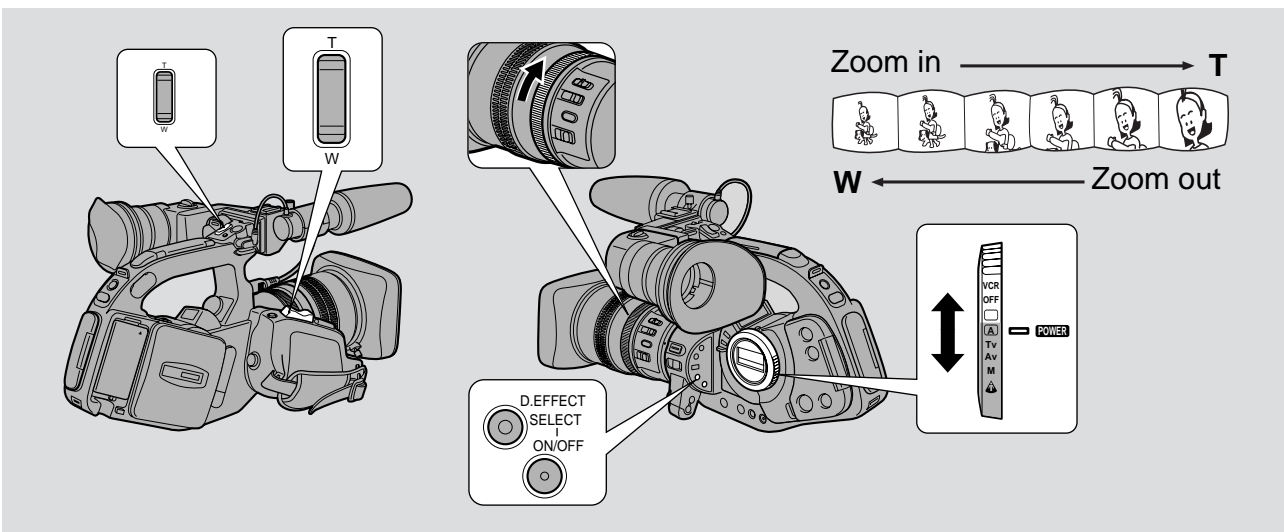

E

Optical zoom (16× for standard lens)

Operate the zoom controls from either the side grip or the camera handle.
Turn the zoom control towards W to zoom out to wide-angle.
Turn it towards T to zoom in to telephoto.

You can also zoom in and out using the lens's zoom ring.

To control the speed of zooming (using the zoom control on the side grip and the lens's zoom ring):

- Move the control/ring slightly to zoom slowly.
- Turn it further to zoom more quickly. (The further you turn the zoom control/ring, the faster the zoom speed.)

The T and W buttons on the wireless controller and the camera handle adjust the picture angle, but not the zoom speed.

Notes:

- When the lens is at the extreme wide-angle position, you can focus on a subject as close as 13/16 in (2 cm).
- Since the zoom changes the picture angle, when using the high speed zoom there are cases when the autofocus can not keep pace with the zoom speed.

32× digital zoom

Activate the digital zoom to double the camera's zoom range.

The zoom control continues to work as usual — the camera automatically switches between optical zooming and digital zooming.

- Image resolution is slightly lower when the magnification exceeds the optical zoom range.

Activating the digital zoom

1. Turn the **POWER** dial to any recording program.
2. Press the **D.EFFECT SELECT** button to move through the list of effects in the viewfinder, until you reach **D.ZOOM**.

- The flashing display changes to show which effect you can select.
- The camera only displays selectable effects.

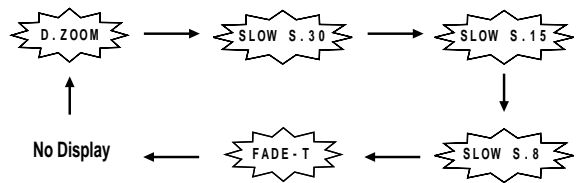

3. Press the **D.EFFECT ON/OFF** button to activate the digital zoom.
 - D.ZOOM is shown constantly in the viewfinder.
4. The digital zoom will remain activated until you press the **D.EFFECT ON/OFF** button to deactivate it. When deactivated, **D.ZOOM** flashes in the viewfinder and you can then press the **D.EFFECT SELECT** button to select a different digital effect, or to turn the digital effects off completely by choosing the blank display.

Notes:

- You cannot select a different digital effect while the digital zoom is still activated.
- The digital zoom remains programmed until you turn it off.

Turning the SuperRange Optical Image Stabilizer On/Off

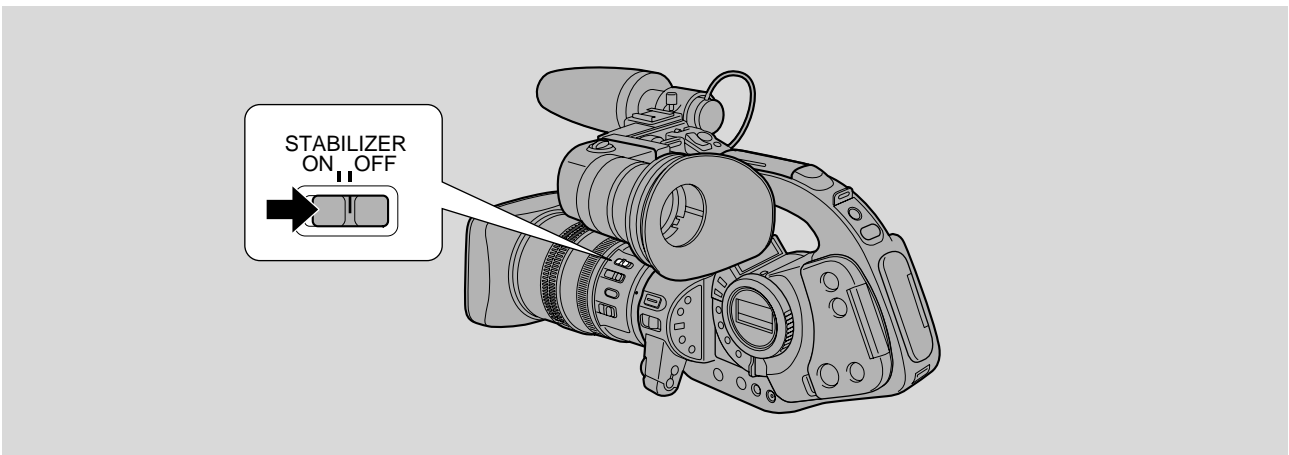

E

The Optical Image Stabilizer can compensate for a wide range of camera movement — you can record stable images even if you are shooting from a moving car.

Before you start recording, slide the STABILIZER switch on the video lens to turn the image stabilizer on or off.

Notes:

- The image stabilizer is designed to deal with a normal degree of camera shake.
- Keep the image stabilizer turned off when the camera is mounted on a tripod.
- Sliding the switch to OFF has no effect when the camera is set to the Easy Recording program.
- The image stabilizer is not as effective as usual when the Extender XL 1.6× (optional) is attached.

Using the ND Filter (for appropriate lenses)

E

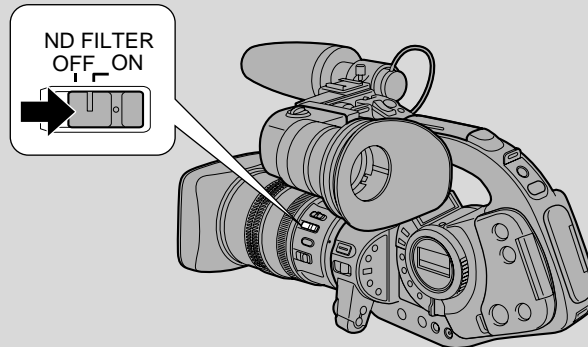

On bright days or when recording very bright scenes, despite the iris being at its smallest aperture, blurring of the image may occur. In such cases, using an ND filter should remove this problem. The 16× zoom lens XL comes with a built-in ND filter.

The ND FILTER switch is located on the body of the XL lens.

Slide the ND FILTER switch to ON to use the filter.

- ND is shown continuously in the display while the ND filter is switched on.

When the camera is set to the Easy or Auto Recording programs (and the XL lens is attached):

- ND ON flashes in the viewfinder to advise you to switch the ND filter on.
- ND ON with the “ON” flashing advises you to fit an external ND filter or that the light conditions are still too bright, despite having switched the ND filter on.
- ND OFF with the “OFF” flashing warns you that the ND filter is no longer suitable for the current conditions. Set the ND FILTER switch to OFF.

Recording

Note:

- Make sure you reset the white balance, if you were using a manual white balance before you turned the ND filter on.

Taking Still Pictures (Photo Mode)

E

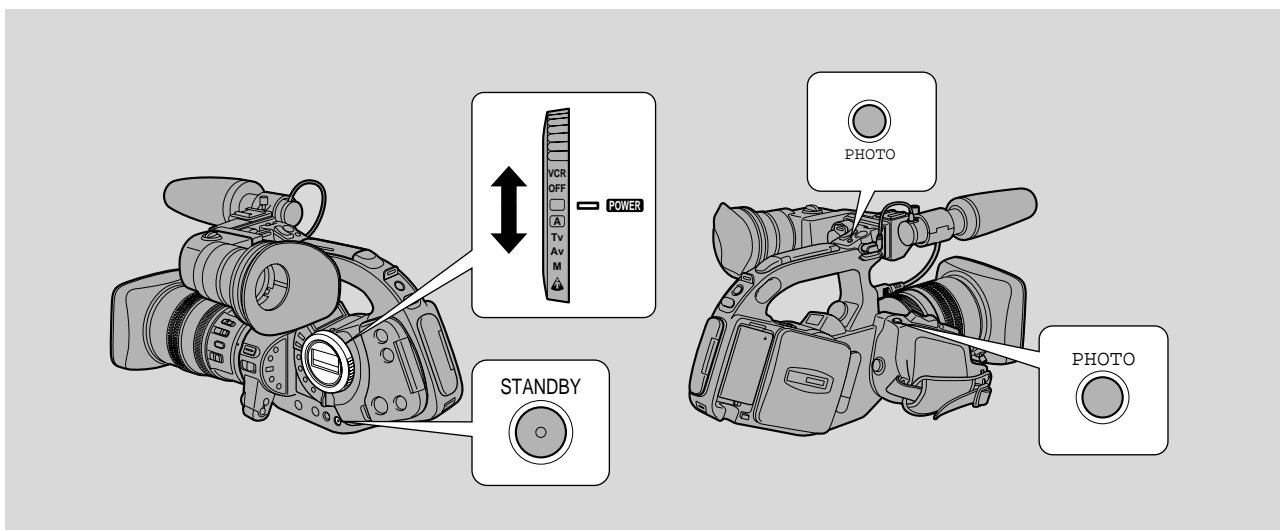

You can record still pictures like a photograph. The camera records the picture to tape for approximately 6 seconds. The exposure is automatically adjusted.

There are two PHOTO buttons, to let you take still images from both gripping positions.

- 1. Set the camera to standby mode (turn the POWER dial to a recording program).**
- 2. Press the PHOTO button lightly.**
 - “PHOTO” flashes at the bottom right of the viewfinder.
 - During autofocus ● flashes white in the viewfinder as the camcorder adjusts the focus and exposure and it is displayed continuously as a green mark when the camera is ready to take the still picture. (The focus, exposure and zoom are now locked. Also you cannot turn the image stabilizer on /off.)
 - To change the still picture before recording: release the button, select a new picture and then press down the PHOTO button lightly once more.
 - If the subject is unsuitable for autofocus (p. 70), the camera may not be able to focus, and ● may continue to flash in the viewfinder. In this case: override the focus temporarily using the lens’ manual focusing ring (p. 44). The green mark lights up.
 - If you are recording using manual focus (p. 44), the ● mark will light up green when you first press the PHOTO button. Focus the camera using the manual focusing ring.
- 3. Press the PHOTO button fully down to take the still picture.**
 - The camera takes the image almost immediately, and then records the “photo” to the tape for approximately 6 seconds. During this time the camera also records the sound, and the viewfinder also shows the still picture.
 - A counter display is shown, that counts up to 6 secs as the camcorder records the picture.
 - disappears from the viewfinder.

Notes:

- While the camera records the still, you cannot use the camera functions (POWER dial/STANDBY button do not respond until recording is complete). This applies even when you haven’t loaded a cassette.
- The wireless controller’s PHOTO button has no half-way setting, press the button and the camera soon takes the “photo”.
- For even greater versatility attach a Canon Speedlite for flash photography (available as an optional accessory, see page 43).
- Only take “photos” where it is bright enough to see the image in the viewfinder.

Choosing the Movie Mode (Normal/Frame)

E

The Frame mode can be used when you want to look at a video, scene by scene, free from field slippage (the “flicker” that normally occurs when you pause a video). The vertical resolution of the image is improved by 1.5×. During playback, pause the video any time you like to view a crystal clear still image in the display or on a connected TV screen. It is also possible to transfer your favorite still pictures to a PC for image enhancement and print out.



1. Turn the **POWER** dial to any recording program except **Easy Recording**.
2. Open the camera menu, and point the arrow at **MOVIE MODE**.
3. Choose the **FRAME** setting and close the menu.
 - FRAME appears in the viewfinder.

Notes:

- To return to normal video shooting, you need to re-select **NORMAL** from **MOVIE MODE** at the camera menu.
- Frame mode cannot be used with the Easy Recording program, on the slow shutter digital effects.
- Frame video may not appear completely smooth during normal playback.

Searching and Reviewing While Recording

Record search

When the camera is in record pause mode, you can use record search to play the tape forwards or backwards to find the point where you want to start or restart recording.

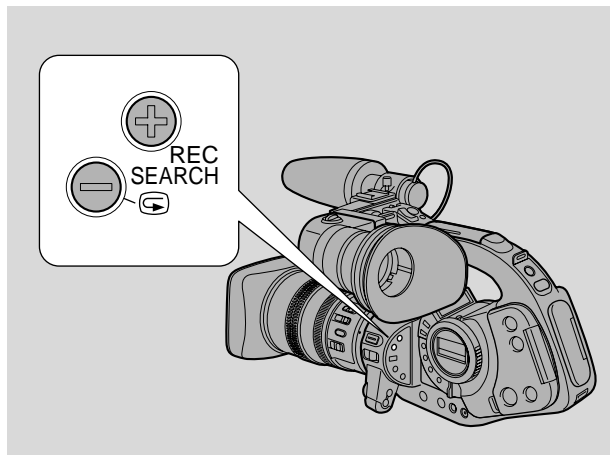

E

1. **Make sure the camera is in record pause mode.**
2. **Press and hold the REC SEARCH + or – button while you check the picture in the viewfinder.**
 - The + button plays the recording forwards and the – button plays it backwards.
3. **Release the button when you find the point where you want to start recording.**
 - The camera returns to record pause mode.

Record review

When the camera is in record pause mode, you can use record review to play back the last few seconds of your recording and then return automatically to record pause mode.

1. **Make sure the camera is in record pause mode.**
2. **Press and release the  (record review) button while you check the picture in the viewfinder.**
 - The camera rewinds the tape, plays back the last few seconds, and returns to record pause mode.

Note:

- Noise may appear on the screen during record search and record review.

Using the Various Recording Programs

E

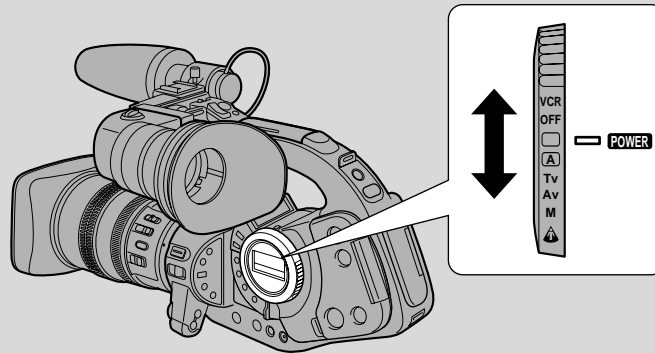

The camera provides you with a choice of six recording programs. They use different combinations of camera settings in order to adjust the exposure and other functions to match the recording situation.

The name of your selected recording program appears constantly on the left of the display, with the exception of the Easy Recording program whose mark is displayed and then disappears after 4 seconds.

Notes:

- Avoid changing programs during recording as the brightness of the image may change suddenly.
- The specialized AE programs are not suitable for all kinds of lighting. The image may flicker, or a bright line may appear on the screen if you use them in the wrong lighting conditions.

Recording

Easy Recording

The simplest way to use the camera is with the POWER dial set to the position. The camera will take care of focus, exposure and other adjustments, leaving you free to point and shoot.



If you select this Easy Recording program, you cannot use:

- Frame movie mode
- Exposure lock or adjust the aperture
- White balance settings
- AGC gain
- Shutter settings
- 16:9 effect
- Slow shutter effects
- Fade trigger

Also, turning off the autofocus and image stabilizer at the lens has no effect.

Auto

In normal recording conditions, set the POWER dial to **[A]** (Auto). This is the same as the Easy Recording program, except that you now have the option of using any of the camera's manual functions — you can adjust focus and exposure, set the white balance, and so on.



AUTO

**Manual**

Select this program for total creative freedom when operating the camcorder. You can set aperture and shutter speeds completely independently to give you exactly the exposure you require.

M

There are 27 shutter speed settings, between 1/60 and 1/15000 of a second and 27 aperture values, between f/1.6 and f/16 (you can also close the iris.)

Spotlight

The exposure is automatically adjusted for glare-free recordings of subjects lit by a concentrated light source.



Giving priority to shutter speed (shutter-priority: Tv)

Use this program to let you select the shutter speed.

The camera sets the appropriate aperture (F number) automatically to give the correct exposure.

When you turn the POWER dial to Tv, the current shutter speed is shown in the viewfinder. Select your desired shutter speed by pressing the SHUTTER ▲ and ▼ buttons.

Tv



You can choose 9 shutter speeds between 1/60 and 1/15,000 of a second.

- If you try to set a shutter speed that is either too high or too low for the shooting conditions, the indicator flashes in the viewfinder. In this case, increase or decrease the setting until the flashing stops, or slide the ND FILTER switch ON/OFF as appropriate before changing the setting.

Notes:

- You can also set the XL1 for slow shutter shooting using the slow shutter digital effects (p. 35).
- When recording in extreme low-light conditions, we recommend the use of a Canon Speedlite or Video Light (available as optional accessories, see page 73).

Giving priority to the aperture (aperture-priority: Av)

Use this program to let you select the aperture (iris diameter) to give you maximum control over the depth of field.

A large F number (a small aperture) gives a greater depth of field.

Av



- Under very bright conditions when you have set the F number to f/16, blurring of the image may occur. Check the image in the viewfinder while setting the aperture.
- When a lens that has a built-in ND filter is attached, if you switch the filter on, the intensity of the light is reduced and the image in the viewfinder may go dark. In such a case, switch the filter off and change the aperture setting.
- When shooting in the (Easy Recording) or (Auto) programs on bright sunny days outdoors, the camera may display “ND ON”/“ND OFF” repeatedly. In this case, it may be effective to switch to the Av recording program and adjust the setting of the F number to between f/5.6 and f/11 (the shutter speed may become higher than usual).

The camera sets the appropriate shutter speed automatically to give the correct exposure. When you turn the POWER dial to Av the current F number is shown in the viewfinder. Select your desired F number by turning the IRIS wheel.

You can choose 8 F numbers between f/1.6 and f/16, and CLOSE to shut the iris completely. If you try to set an F number that is too high or too low for the shooting conditions, the indicator flashes in the viewfinder. In this case, increase or decrease the setting until the flashing stops.

Note:

- The camera memorizes the latest Tv or Av value until a new value is set. Turning off the camcorder or changing the recording program does not erase the stored value.

Activating the Slow Shutter

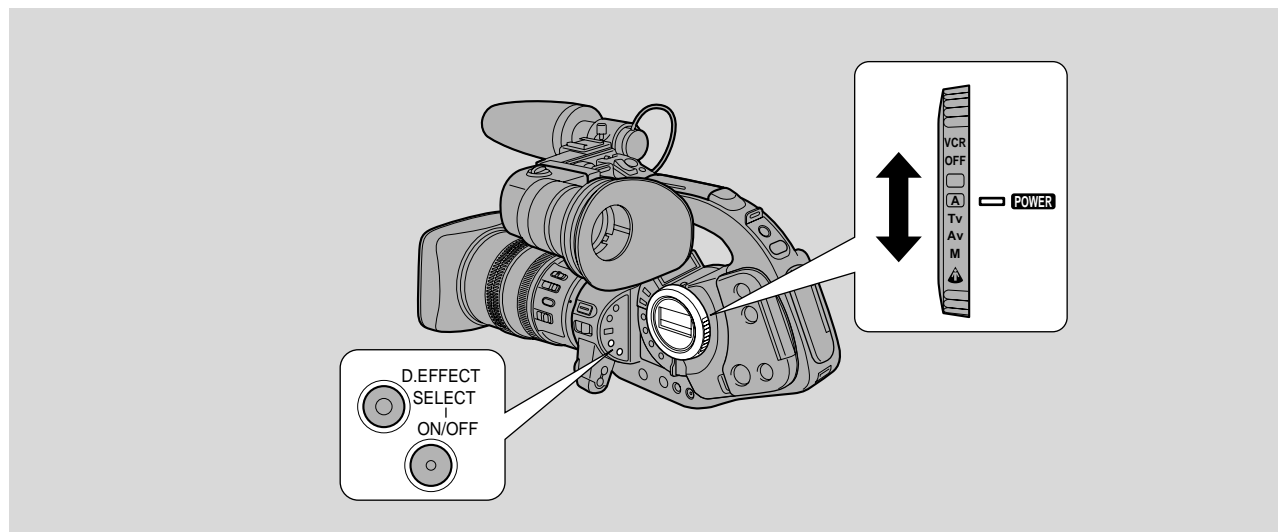

You can select one of three SLOW shutter effects: 1/8, 1/15 or 1/30 of a second.

1. Turn the **POWER** dial to the Auto or Manual recording program.
2. Press the **D.EFFECT SELECT** button to move through the list of effects in the viewfinder, until you reach the **SLOW** setting of your choice.

- The flashing display changes to show which effect you can select.
- The camera only displays selectable effects.



3. Press the **D.EFFECT ON/OFF** button to activate the slow shutter.
 - The name of your chosen effect is shown constantly in the viewfinder.
4. The slow shutter will remain activated until you press the **D.EFFECT ON/OFF** button to deactivate it. When deactivated, the effect name flashes in the display and you can then press the **D.EFFECT SELECT** button to select a different digital effect, or to turn the digital effects off completely by choosing the blank display.

Notes:

- You cannot select a different digital effect while the current effect is still activated.
- You can only use the slow shutter with the Auto or Manual recording programs.
- You cannot select a slow shutter; [SLOW S.] is shown in the display when:
 - The movie mode is set to FRAME.
 - You have pressed the EXP. LOCK button.
 - You have chosen a shutter speed greater than 1/60 in the manual recording program (in this case set the shutter speed to 1/60 by pressing the shutter ▲ button).
- The slow shutter setting is remembered by the camera, until you change the POWER dial setting.

Selecting the Audio Mode

E

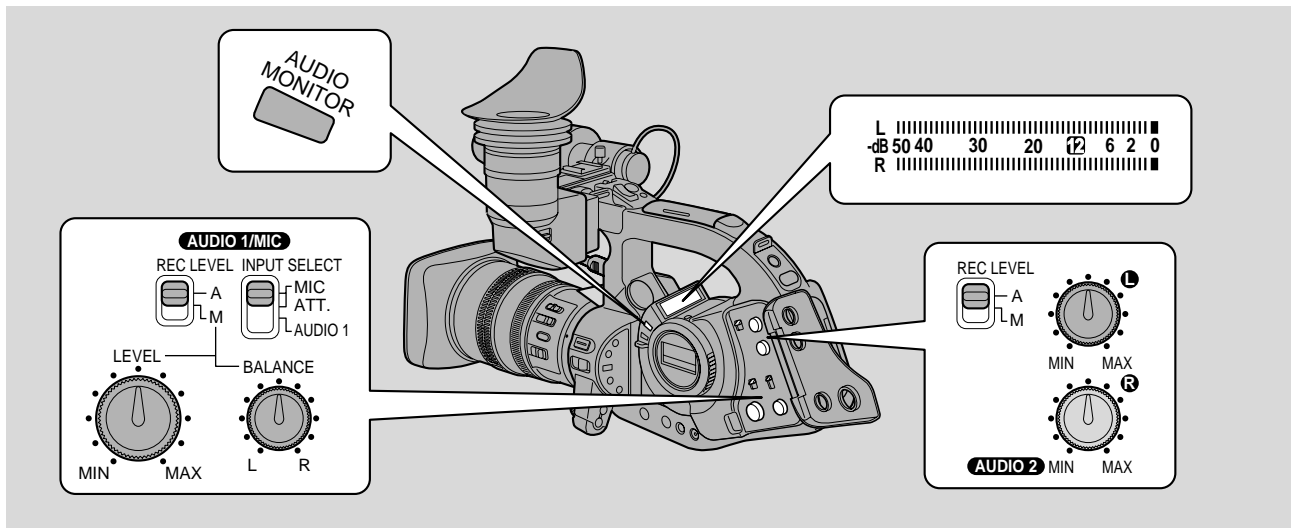

The XL1 can record sound in three audio modes:

- 16-bit (48kHz, 2 channel) for the highest sound quality
- 12-bit ST-1 (32kHz, 2 from 4 channels) for recording on two channels (stereo 1), leaving two channels (stereo 2) free for you to add new sound at a later date.
- 12-bit ST-1, 2 (32kHz, 4 channels) for simultaneous recording on four channels (stereo 1 and stereo 2).

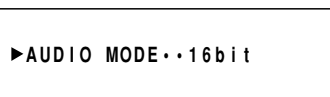

Recording

1. To switch between the three modes, open the camera menu and select **AUDIO MODE**.
2. Select a mode, and close the menu.
 - The name of your chosen mode is displayed in the viewfinder and main LCD panel.

After selecting the audio mode you can set the audio input:

- The settings for 16-bit and 12-bit stereo 1 audio are the same, and are explained under “Two Channel Recording” on the next page.
- The settings for 12-bit stereo 1, 2 are explained under “Four channel Recording” on page 38.

Notes:

- You cannot add new sound to a tape using this camcorder.
- For audio output details, including how to play back a tape that has new sound on stereo 2, see page 60.

Setting the Audio Input — Two Channel Recording

Set the input for Stereo 1 in one of two ways, A or B, depending on the source for the input:

E

A. Using the supplied microphone or attaching an external microphone to the mini jacks

1. **Change the audio mode at the menu if necessary (see page 36).**
2. **Slide the INPUT SELECT switch to MIC.**
 - This assigns the MIC mini jacks as the source for the audio input.
 - In place of the supplied microphone, you can attach an external microphone to the mini jacks.
 - If you wish to use the attenuator to provide more natural sound without distortion (when recording in loud places) slide the INPUT SELECT switch to ATT.

B. Using the AUDIO 1 RCA jacks

1. **Change the audio mode at the menu if necessary (see page 36).**
2. **Slide the INPUT SELECT switch to AUDIO 1.**
 - This assigns the AUDIO 1 RCA jacks as the source for the audio input.



3. **Open the camera menu and select the appropriate option for AUDIO 1 IN:**
 - LINE: To record sound from a VCR, CD or other line in devices.
 - MIC ATT20: To record sound using a microphone, when the sound level is high.
 - MIC: To record sound using a microphone (e.g. attached via the optional MA-100 Microphone Adapter/Shoulder Pad).

Setting the recording level for two channel recording

In normal recording conditions, the camera sets the audio recording level automatically, as long as you slide the REC LEVEL switch to A.

You can also set the recording level manually:

1. **Slide the REC LEVEL switch of the AUDIO 1/MIC controls to M.**
 - MANU appears in the audio LCD panel.
2. **Turn the LEVEL dial to adjust the recording level and BALANCE dial to adjust the balance between the two inputs.**
 - Check the levels for each channel in the audio LCD panel.
 - If the level exceeds the 0dB point, it is essential for you to monitor the sound using headphones.
 - Adjust the headphone volume by rotating the PHONES LEVEL dial.

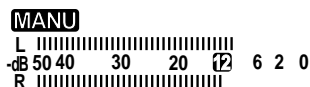

Setting the Audio Input — Four Channel Recording

E

1. Set the audio mode to “12 bit ST-1, 2”.
2. Set the input for stereo 1 in exactly the same way as for two channel recording.

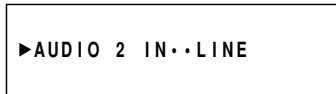

3. Set the input for stereo 2 by connecting a device to the **AUDIO 2 RCA** jacks and then selecting the appropriate option for **AUDIO 2 IN**:
 - LINE: To record sound from a VCR, CD or other line in devices.
 - MIC ATT20: To record sound using a microphone, when the sound level is high.
 - MIC: To record sound using a microphone (e.g. attached via the optional MA-100 Microphone Adapter/Shoulder Pad).

Setting the recording level for four channel recording

In normal recording conditions, the camera sets the audio recording level automatically as long as you slide the REC LEVEL switch to A (automatic).

You can also set the recording level manually:

1. Set the recording level for stereo 1 in exactly the same way as for two channel recording.
2. Set the recording level for stereo 2 by sliding the REC LEVEL switch of the AUDIO 2 controls to M (manual).
3. Turn the L and R dials to independently adjust the recording levels of the two inputs (corresponding to the L and R channels of the AUDIO 2 RCA jacks).
 - Check the levels for each channel in the audio LCD panel.
 - It is essential for you to monitor the sound using headphones.
 - Adjust the headphone volume by rotating the PHONES LEVEL dial.

Recording

Making a Sound Check

Press the AUDIO MONITOR button to make a sound check — stereo 1 only (ST1), stereo 2 only (ST2) or both (MIX) [each in turn].

- Your choice is selected a few seconds after you last pressed the button, and shown in the viewfinder and audio LCD panel.
- Unlike selecting the audio output in VCR mode, you cannot mix the balance at this point — even if VARIABLE is chosen at the VCR menu, it is fixed during camera mode.

E

Headphones

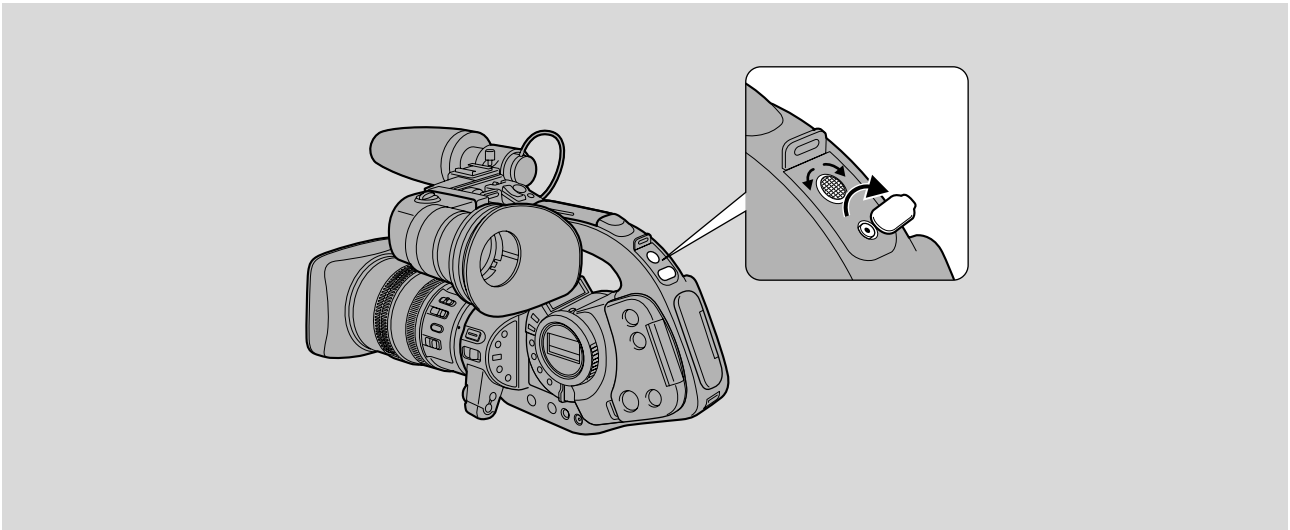

You can monitor the sound while recording by attaching stereo headphones to the camera's  terminal. Adjust the headphone volume by rotating the PHONES LEVEL dial.

Fading In and Out Between Scenes

E

Fade trigger

When you start recording, the scene gradually fades in from a black screen. When you stop recording, it gradually fades out.



Set the fade trigger each time you wish to use it (both before you fade in and again before you fade out).

FADE-T is shown constantly in the viewfinder when it is ready for use.

Activating the fade trigger

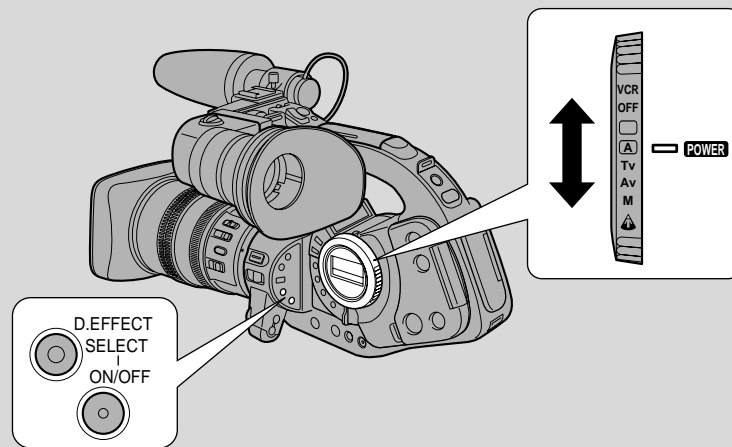

Recording

1. Turn the **POWER** dial to any recording program (except Easy Recording).

2. Press the **D.EFFECT SELECT** button to move through the list of effects in the viewfinder, until you reach **FADE-T**.

- The flashing display changes to show which effect you can select.

3. Press the **D.EFFECT ON/OFF** button to set the fade trigger ready for use.

- FADE-T is shown constantly in the viewfinder.

4. Start or stop recording.

- The fade trigger is now activated — the scene will fade in or out.
- FADE-T then starts to flash again in the viewfinder.
- If you wish to use the fade trigger again, press the D.EFFECT ON/OFF button. If not, you can press the D.EFFECT SELECT button to select a different digital effect, or to turn the digital effects off completely by choosing the blank display.



Notes:

- You cannot select a different digital effect while the fade trigger is still turned on.
- You can turn the fade trigger off before you use it by pressing the D.EFFECT ON/OFF button again.
- You are unable to use the fade trigger with the Easy Recording program.
- The fade trigger setting is remembered by the camera, until you change the POWER dial setting.

16:9 (Widescreen TV recording)

Produces images in the 16:9 format for playback on widescreen TVs.



▶16:9.....OFF

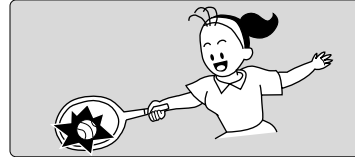

1. Select **16:9** from the camera menu and turn the effect **ON/OFF**.
2. Press the **MENU** button once more to close the menu.

Notes:

- “16:9” is shown in the viewfinder when you switch the 16:9 effect on.
- You cannot use the 16:9 digital effect with the Easy Recording program.
- If you play back a recording made for 16:9 on a normal TV screen, the image will appear to be vertically “squashed” (compressed).

Setting the Self-Timer

E

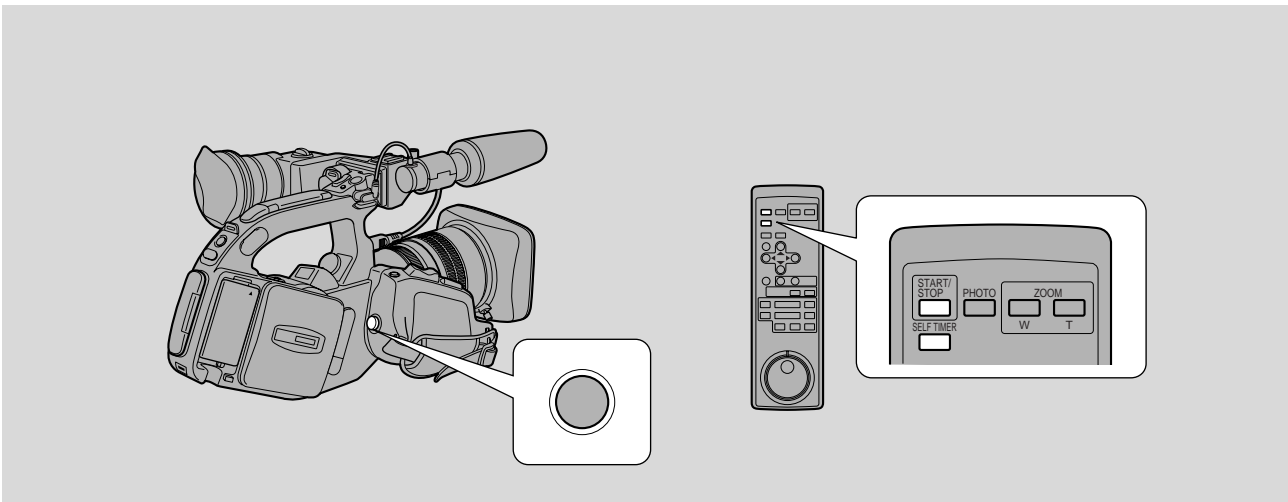

1. Press the wireless controller's SELF TIMER button.

- SELF TIMER appears in the viewfinder.

2 Press the wireless controller's START/STOP button.

- The camera starts to record after a 2 second countdown period (or after 10 seconds if you press the start/stop button on the camera). The time remaining counts down in the viewfinder (e.g. "5 sec").
- SELF TIMER disappears from the viewfinder when recording begins.

3. Press the START/STOP button to end recording.

- In photo mode, set the self-timer in a similar way, but press the PHOTO button in place of the start/stop button. The focus and exposure are set before the countdown is complete and the green ● mark is displayed.

Recording

Notes:

- Initially the tally lamps flash once a second, then just before recording starts they flash more quickly for a few seconds before the camera starts to record.
- To cancel the self-timer press the SELF TIMER button once more before recording. Once the countdown has begun, press the SELF TIMER button to turn it off.
- Cancel the self-timer at any stage by turning the power off or pressing the STANDBY button.
- If you press the SELF TIMER button when the recording displays have been turned off (p. 24), the self timer display does not appear in the viewfinder, until you press the start/stop button to start the countdown.

Using a Canon Speedlite for Flash Photography (optional)

For SLR-style flash photography, attach a Canon Speedlite 380EX to the camera using the optional FA-100 Flash Adaptor. Attach its hot shoe cube to the XL1's accessory shoe, and the flash cable to the flash adapter terminal.

Use the camera in exactly the same way as you would normally in photo mode (p. 29). Turn on the Speedlite using its main switch, and wait for it to charge. When you press the PHOTO button halfway down, the camera sets the autofocus and the zoom is locked. Pressing the PHOTO button fully down releases a pre-exposure flash that sets the flash intensity, exposure and white balance. The main flash is then sent out.

- In dark recording situations, a supplementary light beam is sent out by the flash for approx. seven seconds to illuminate the subject, while you hold the camera's PHOTO button halfway down. This supplementary light only operates during autofocus.

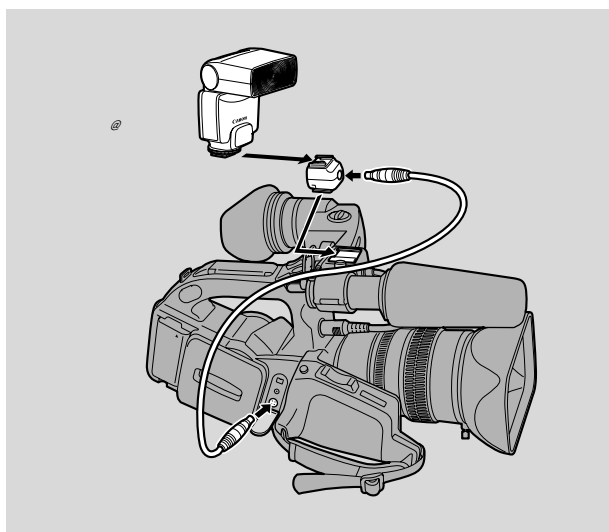

E

Flash Charging

While the flash is charging, a white ⚡ flashes in the viewfinder.

When the flash is fully charged a green ⚡ lights up constantly in the viewfinder.

- Although it is possible to record a still image while the Speedlite is still charging, the flash will not go off. In addition, the Speedlite cannot charge while you are holding the PHOTO button halfway down.
- ⚡ disappears from the display while the camera records the still picture.
- If the ⚡ mark does not appear in the viewfinder when you turn the flash on, make sure that the flash unit is slid fully home on the hot shoe cube.

Notes:

- For full details of how to use the Speedlite, refer to its instruction manual.
- If you use the Speedlite in the shutter-priority (Tv), you can choose any shutter speed between 1/60 and 1/1000.
- In the aperture-priority (Av), you can choose any F number, but an F number of less than f/8 gives the best results.
- You cannot use the Speedlite with the:
 - Manual recording program.
 - Exposure Lock. (⚡ goes out if you press the EXP. LOCK button. It reappears when you turn the lock off, by pressing the EXP. LOCK button.)
- Turn the Speedlite unit off when you do not require the flash.
- The Speedlite can not be used with an SA-1 Adapter Bracket.
- The 380EX Speedlite's internal automatic zoom is set to 24 mm when attached to XL1. The guide number is set to 21.
- You are unable to use the Speedlite 380EX's bounce flash with the XL1.
- The FA-100 Flash Adaptor contains a special cable. Do not use other cables to attach a flash unit.
- You cannot use a flash with an EF lens attached to the XL1.

Adjusting the Focus

E

The camera can focus automatically. All you have to do is point it, and whatever is in the center of the display will usually be in sharp focus. If it does not seem to be focusing well, it may be because the subject is not suitable for autofocus (page 70). Also, if you attach a filter other than UV or ND, the autofocus may not work as effectively.

It also has functions which give you more control over focusing. Operate these from the body of the XL lens.

Temporary focus override

You can adjust the focus temporarily without turning autofocus off. Turn the lens's focusing ring to set the focus. Autofocus will resume as soon as you take your hand away from the focusing ring.

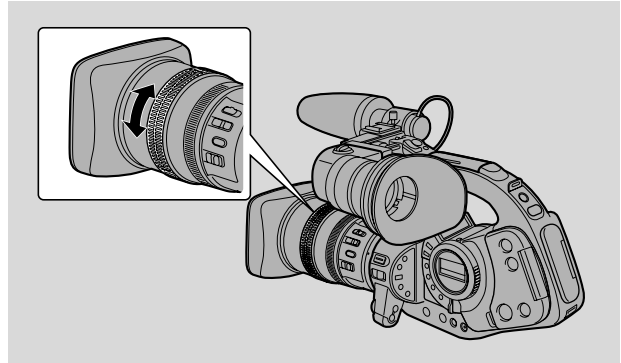

Manual focus

1. Slide the focus switch on the body of the XL lens to M (manual).
2. When using a zoom lens, rotate the zooming ring to the telephoto end.
3. Rotate the focusing ring to adjust the focus.
4. When using a zoom lens, use the zooming ring to reframe the subject.
 - To resume autofocus, slide the focus switch to AF (auto).
 - If you focus manually then leave the camcorder with the power turned on, you may lose focus on your subject. This possible slight shift in focus is due to a rise in temperature in the camcorder interior and lens. Check the focus before resuming shooting.

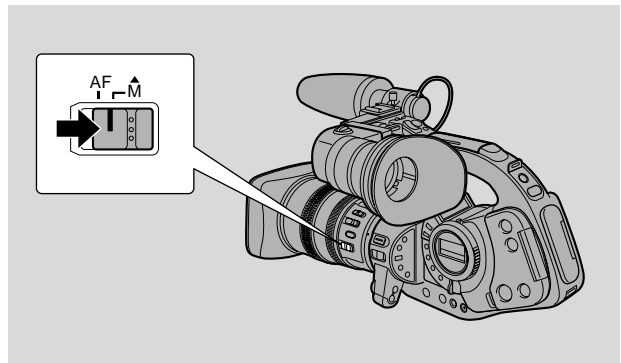

Push autofocus

Press the PUSH AF button during manual focusing, to quickly adjust the focus automatically. The camera will continue to focus automatically as long as you hold down the button. Release the button to continue to set the focus manually.

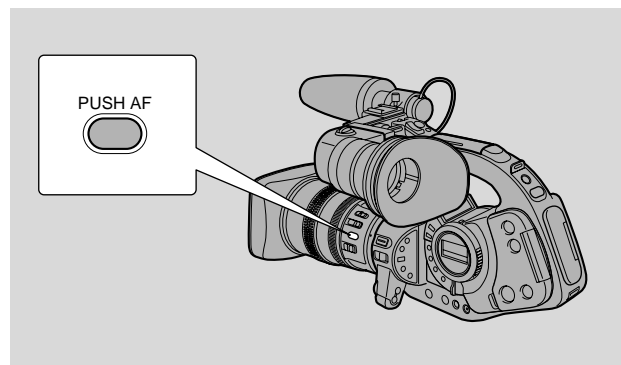

Adjusting the Exposure

Set the aperture value (of the iris) and the shutter speeds completely independently to give you total creative freedom in setting the exposure.

E

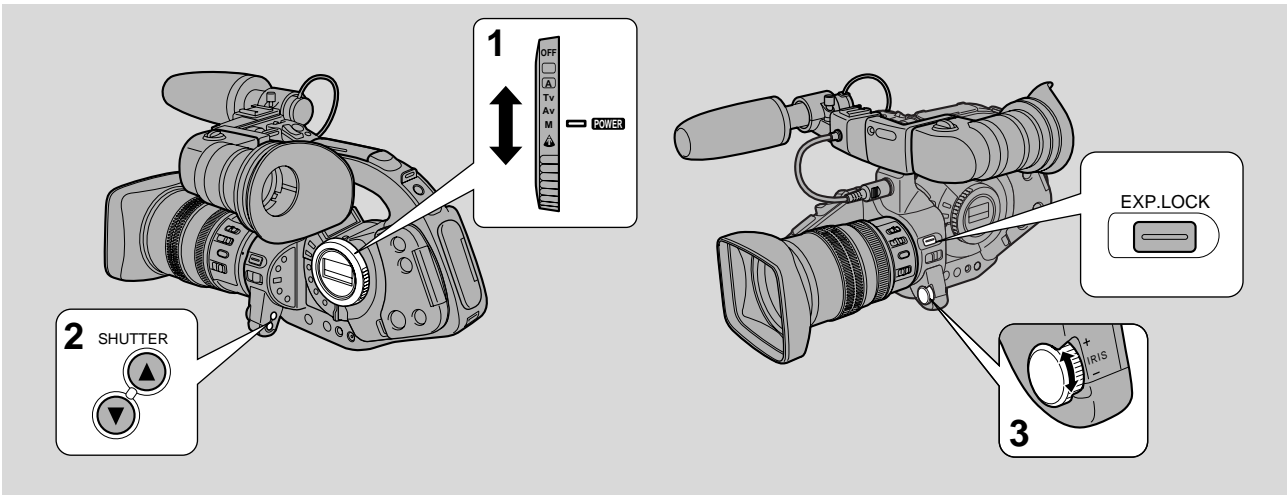

- 1. Turn the POWER dial to the Manual recording program.**
- 2. Press the SHUTTER ▲ and ▼ buttons to increase or decrease the shutter speed.**
 - Set the shutter to one of 27 speeds between 1/60 and 1/15,000 of a second.
- 3. Turn the IRIS wheel to open or close the iris.**
 - Set the aperture value to one of 27 F numbers between f/1.6 and f/16, or select CLOSE to close the iris completely.

You can also vary the exposure manually in the Auto, Tv and Av modes, but you must first lock the exposure to activate the SHUTTER buttons and the IRIS wheel.

- The maximum and minimum settings for the shutter and aperture are the same, but there are 9 possible speeds and 8 possible F numbers.

Exposure lock

You can lock the exposure at the current level in order to control the brightness of the image.

To lock the exposure, press the EXP. LOCK button. Press it again to return to the automatically set exposure level.

Notes:

- You cannot lock the exposure in the M (Manual) recording program.
- The standard exposure level depends on which recording program you have selected, but the shutter normally operates at 1/60 of a second.
- Exposure lock is canceled if you change the setting of the POWER dial.
- You cannot use exposure lock or adjustment when the POWER dial is set to the □ (Easy Recording) or ▲ (Spotlight) position.

Using AE Shift

E

By controlling the level of the automatic exposure (AE) function, you can lighten or darken the image slightly. This allows you to compensate for backlit subjects or subjects with predominately dark or light tones.

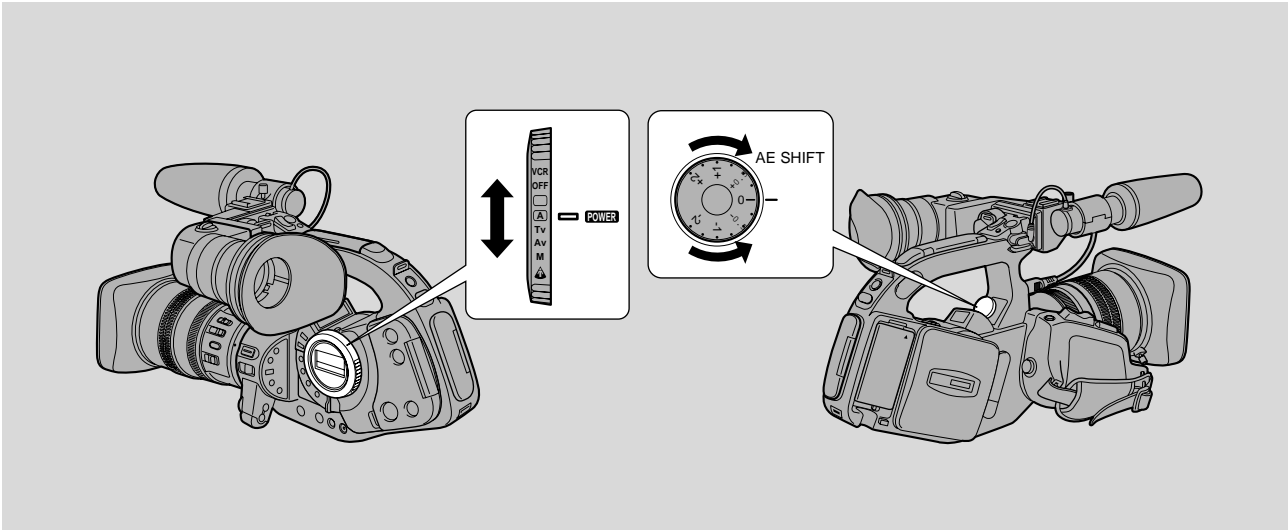

- 1. Turn the POWER dial to the Auto, Tv or Av recording program.**
- 2. Turn the AE SHIFT dial to adjust the AE to your desired level.**
 - To make the image brighter, turn the controller towards the + settings.
 - To make the image darker, turn the controller towards the – settings.

Note:

- AE shift does not function in the Easy, Manual or Spotlight Recording programs.

Using the Zebra Pattern

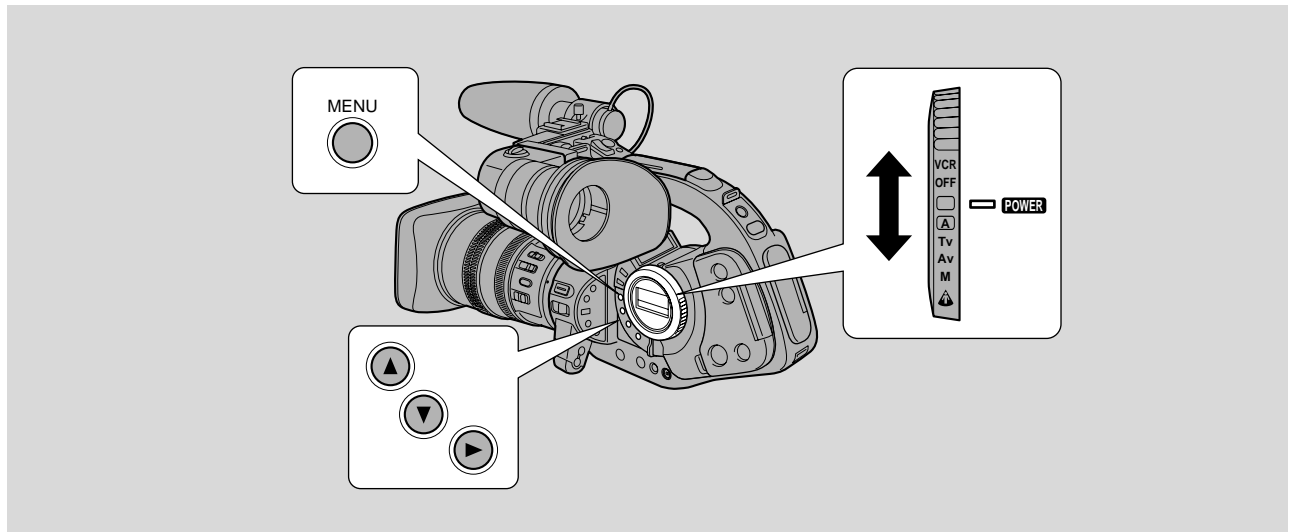

E

The zebra pattern is a series of diagonal stripes that appear in the viewfinder to highlight areas of overexposure. Use as a guide to setting the aperture (iris) and shutter speed.

1. Open the camera menu and select **ZEBRA**.
2. Select the **ON** setting and close the menu.



▶ZEBRA.....ON

Note:

- The camera does not record the zebra pattern, it is only shown in the viewfinder.

Adjusting the Gain

E

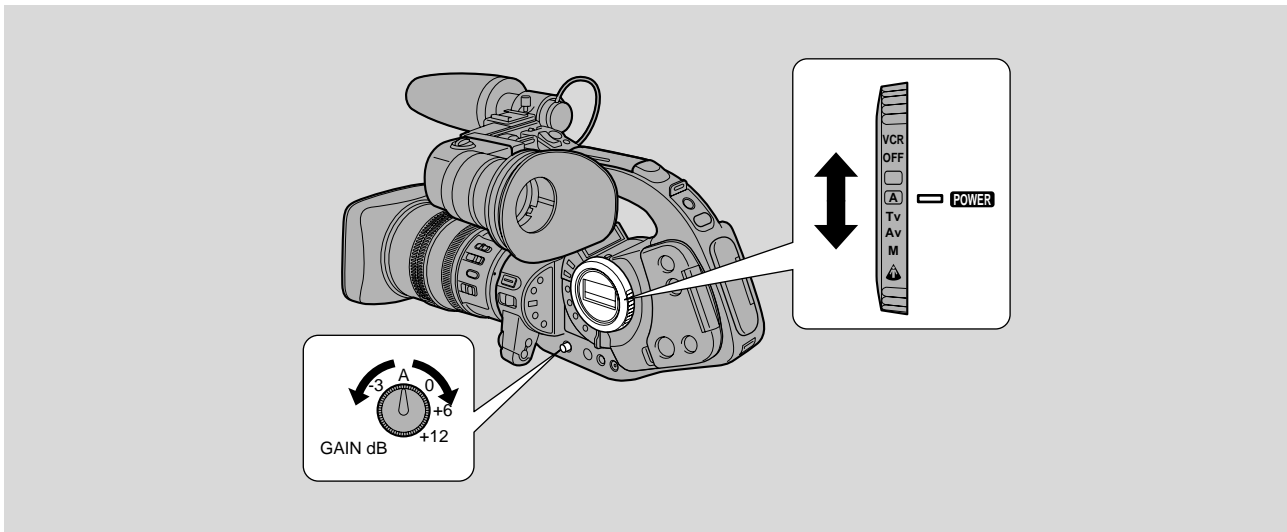

When the GAIN knob is set to **A** (auto) the camera adjusts the gain automatically. You can also rotate the GAIN dial to one of the five preset levels that range from -3 to $+12$ dB.

1. Turn the **POWER** dial to any recording program except **□** (Easy Recording) or **▲** (Spotlight).
2. Press the **GAIN** knob so that it pops out. You can now turn it to adjust the gain to your desired level.
 - The gain level you select appears in the viewfinder.
 - Push the knob back in when you have finished making adjustments.

-3dB:	Low noise recording for indoor, low light or low contrast scenes.
0dB:	Low noise, life-like color reproduction of illuminated scenes at night.
+6dB/+12dB:	Brighten indoor or low-light scenes (when the iris is fully open). Gain-up to enable you to increase the depth of field from using a smaller iris aperture.

Recording

Note:

- You cannot use the GAIN in the Easy Recording or Spotlight recording programs.

Adjusting the White Balance

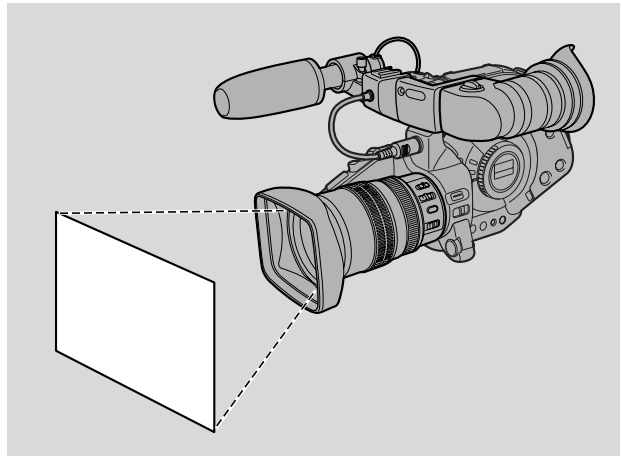

The camera's auto white balance system compensates for a wide range of lighting conditions. Although slight variations are unavoidable, colors will appear natural in virtually every situation.

In some cases, you will get better results by setting the white balance manually.







E

The XL1 has two modes other than fully auto (A) and manual ():

-  Indoor mode (3200°K light)
-  Outdoor mode (5600°K sunlight)

Setting the white balance

1. Turn the POWER dial to any recording program (except the Easy Recording program).
2. Press the white balance selector knob so that it pops out. You can now turn it to choose between A for auto white balance,  for indoor lighting,  for outdoor lighting, or turn it to the right to set the white balance manually.
 -  /  appears in the viewfinder when you set the white balance to the indoor/outdoor modes.



After turning the knob to the right, you can go on to set the white balance manually:

- a) Point the camera at a white object (such as a sheet of paper) and if you are using a zoom lens, zoom in until it fills the display.
- b) Press the WHITE BALANCE set button.
 -  flashes quickly in the viewfinder and then remains lit, to show that the camera has set the white balance.
 - Depending on the light source, the flashing may at times change to a slower speed, rather than remain lit. The result will remain better than with the auto setting, and you can continue recording.
- c) Turn the white balance selector knob back to A to return to the auto setting. Push the knob back in when you have finished making selections.

Setting the white balance manually will probably work better than auto white balance when shooting:

- Subjects with one dominant color, such as sky, sea or forest.
- Close-ups.
- In rapidly changing lighting conditions.
- In places lit by certain types of fluorescent or mercury vapor lights.

Notes:

- If the lighting conditions change, reset the white balance by first returning to the auto setting, and then reselecting the manual balance.
- Try to record with light from a single source. Correct white balance cannot be obtained for two types of lighting at once.
- You cannot set the white balance manually or use the indoor/outdoor modes when the POWER dial is set to the (Easy Recording) program. If you are already using a mode other than auto, the white balance returns to auto while you are in the (Easy Recording) program.
- When you push the STANDBY button without changing the POWER dial, the current white balance setting remains in the memory.
- If you shoot with studio/video lighting, use the  (indoor) mode.
- If you shoot under fluorescent lights use the automatic white balance or set the balance manually, since the camera may not adjust the white balance correctly in the  mode.
- When you turn the camera off, the camera remembers your white balance setting.

Playing back a Cassette

E

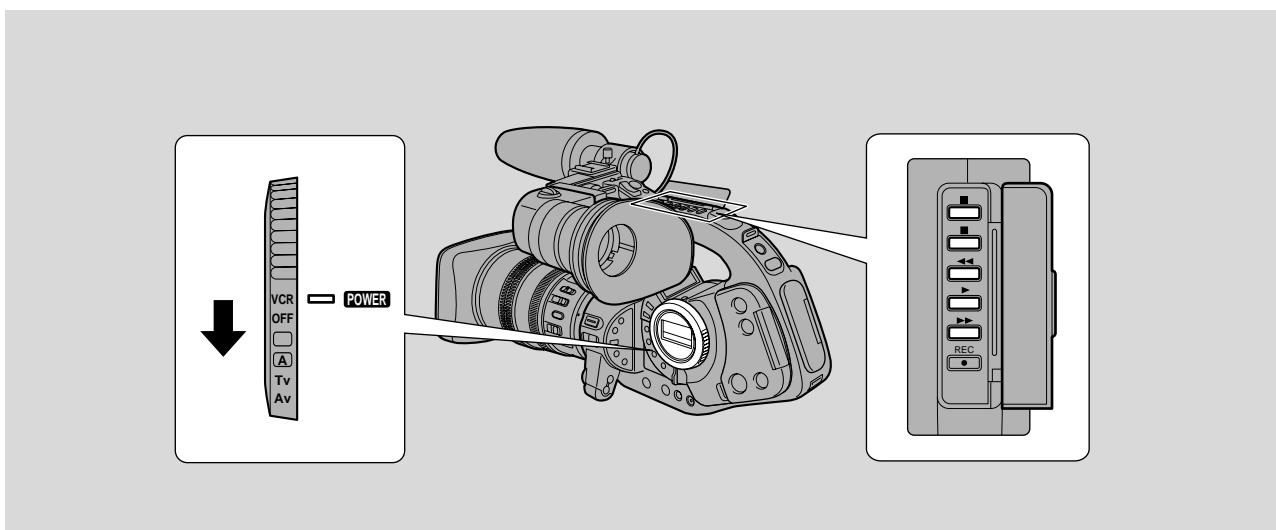

You can use the viewfinder for instant, on-the-spot playback.

To play back your recordings on a TV, see p. 56.

To use the wireless controller, see p. 20.

Note:

- To avoid accidental recording, make sure that you slide the tab on the cassette so that it exposes the hole (the switch position is usually labelled SAVE or ERASE OFF).

1. Attach a power source and turn the POWER dial to VCR.

2. Load the cassette.

3. Press the PLAY ► button to start playback.

- To end playback, press the STOP ■ button.
- To wind the tape forwards, stop playback and press the FF ►► button.
- To wind the tape backwards, stop playback and press the REW ◀◀ button.
- If the playback picture is rough (mosaic-like noise), clean the video heads using a Canon DVM-CL Digital Video Head Cleaning Cassette or a commercially available digital video head cleaning cassette.

Playback

Other playback modes

Playback Pause

To view the video as a still picture press the PAUSE ■■ button. To resume normal playback, press it again, or press the PLAY ► button. The camera automatically goes into stop mode after about five minutes' playback pause.

Edit Search

When the camera is in playback pause, you can use edit search to play the tape forwards or backwards to find the point where you want to start or restart editing.

Press and hold the edit search + and – buttons (the REC SEARCH buttons) during playback, while you check the picture in the viewfinder.

- The + button plays the recording forwards and the – button plays it backwards.

Release the button when you find the point where you want to start editing.

- The camera returns to playback pause.

Fast Forward Playback

To play back the recording at about 9.5 times normal speed, press and hold the FF ►► button during normal playback or press and hold the FF ►► button during normal fast forward.

Rewind Playback

For reverse playback at about 9.5 times normal speed, press and hold the REW ◀◀ button during normal playback or press and hold the REW ◀◀ button during normal rewind.

Special playback

E

These can only be operated from the wireless controller (p. 20)

Frame Advance

To play back frame by frame, press the +/|||▶ button repeatedly during playback pause. Press and hold to play back continuous frame advance.

Frame Reverse

To play back on reverse frame by frame, press the -/◀||| button repeatedly during playback pause. Press and hold to play back continuous frame reverse.

Slow Forward Playback

To play back at about 1/5 normal speed, press the SLOW ▶ button during normal playback. Press the PLAY ▶ button to return to normal playback.

- The camera automatically returns to playback after about 30 seconds of slow playback.

Slow Reverse Playback

To play back in reverse at about 1/5 normal speed, press the -/◀||| button and then the SLOW ▶ button during normal playback.

Press PLAY ▶ to return to normal playback.

- The camera automatically returns to ×1 reverse playback after about 30 seconds of slow playback.

Reverse Playback

To play back in reverse at normal speed, press the -/◀||| button during normal forward playback. Press the PLAY ▶ button to return to normal forward playback.

Forward ×2 Playback

Press the ×2 button during normal playback.

Press the PLAY ▶ button to return to normal playback.

Reverse ×2 Playback

Press the -/◀||| button and then the ×2 button during normal playback.

Press the PLAY ▶ button to return to normal playback.

Shuttle Dial

Use the shuttle dial in play or playback pause mode to control the playback speed and direction. Turn the shuttle dial to different angles (see figure) to select slow, ×1 and ×2 playback modes (both forward and reverse), as well as fast forward and rewind playback. Turn it fully to the left/right to rewind/fast forward while the tape is stopped.

Jog Dial

Turn the Jog dial during playback or playback pause for frame advance/reverse or slow forward/slow reverse playback (depending on how far you turn the dial).

- When you stop turning the dial, the camcorder goes into playback pause mode.

Note:

- Mosaic-like noise appears on the screen during some of the VCR modes.

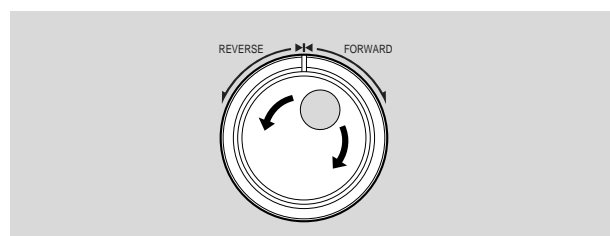
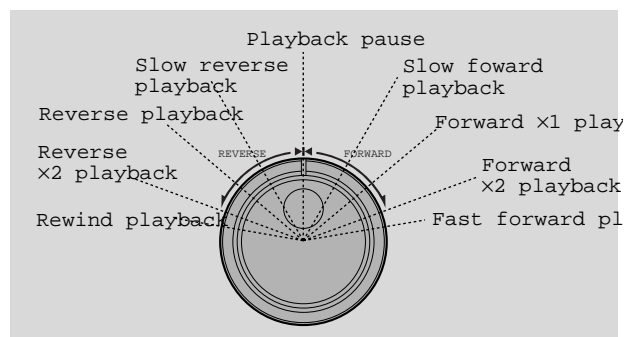

Playback

Displaying Data Code

E

A data code, containing the date and time the recording was made and other camera data (shutter speed and exposure settings) is automatically recorded on a special data section of the tape.

During playback, the data code can be displayed or hidden while the camera is in play, reverse playback, slow forward/reverse playback or frame advance/reverse.

Press the wireless controller's DATA CODE button.

- Press it once to display, once more to hide it.

The camera playback condition displays are not shown when the data code is displayed.

You can also choose which type of data code to display — either the date/time, camera data or both.



1. Select **DATA CODE** from the **VCR** menu.
2. Choose between **DATE/TIME**, **CAMERA DATA** and **CAM. & D/T**.
3. Press the **MENU** button once more to close the menu.

Notes:

- To avoid accidental recording, make sure that you slide the tab on the cassette so that it exposes the hole (the switch position is usually labelled **SAVE** or **ERASE OFF**).
- The data code will read “— — —” in the following situations:
 - When the playback is stopped.
 - During playback of a blank section of tape.
 - If the tape was recorded before entering the date and time in the camera's memory.
 - If the tape was recorded on a camera without a data code function.
 - If noise or tape damage prevents the data code from being read.
- Data code is not displayed during high speed playback modes.
- If a recording made on **XL1** is played back on a different **DV** camcorder, the data code may not be displayed correctly.

Playback

Searching Through Your Recorded “Photos” (Photo Search)

E

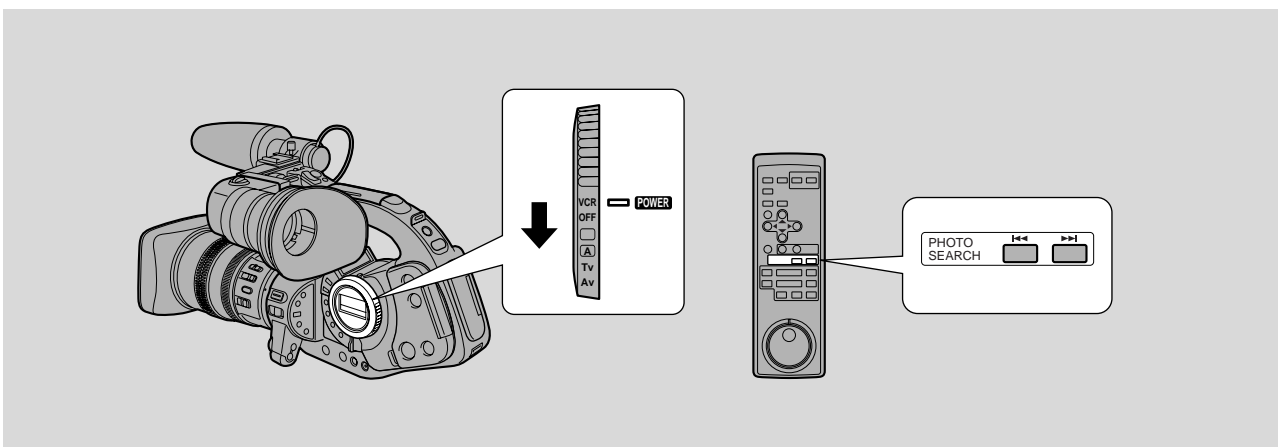

Move quickly through still pictures recorded anywhere on a tape.

- You can only use this function from the Wireless Controller.

1. Turn the POWER dial to VCR.

2. Press the ◀◀ and ▶▶ buttons to move backwards or forwards through the still pictures.

- Press once to move to the start of the previous/next still pictures on the tape.
- Press more than once to move to the corresponding still picture (up to a maximum of 10 times), e.g. press the ▶▶ button 5 times to move forward 5 still pictures on the tape.
- PHOTO SEARCH appears in the middle of the display alongside the ◀◀ or ▶▶ mark and the number of photos to search through.

Notes:

- Press the ■ button to end your photo search.
- If you begin a search very close to the start of a recorded still picture, the camera may skip straight past it.

Connections for Playback on a TV Screen

E

You can connect the camera to a TV or VCR in order to play back your recordings. You will need to attach a power source to the camera (see p. 13).

See your TV or VCR instruction manual for further details.

If your TV (or VCR) has an S-video input terminal

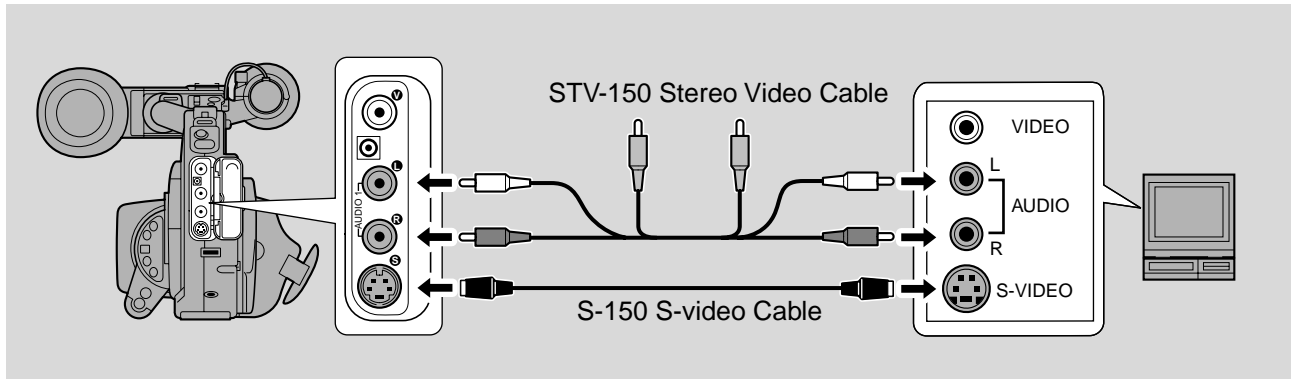

- Use the S-150 S-video Cable to connect the S-video terminal (S). Use the STV-150 Stereo Video Cable, to connect the AUDIO terminals. Connect the white plug to the white AUDIO terminal (L) (left). Connect the red plug to the red AUDIO terminal (R) (right). Do not connect the yellow plug.
- Set the TV/VIDEO selector on the television to VIDEO.
- If you are connecting the camera to a VCR, set the input selector on the VCR to LINE.

If your TV (or VCR) has audio/video input terminals

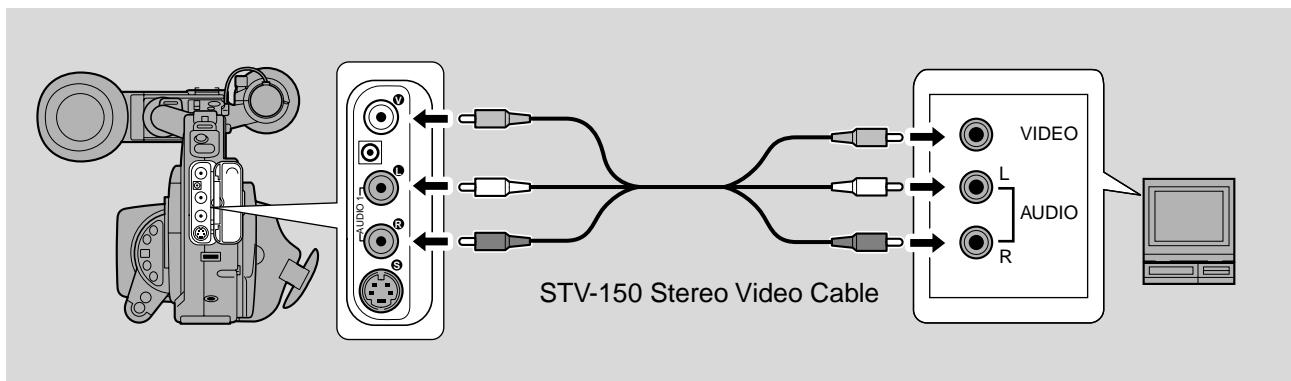

Playback

- Connect the camera using the STV-150 Stereo Video Cable. Connect the white plug to the white audio terminal (L) (left). Connect the red plug to the red audio terminal (R) (right). Connect the yellow plug to the yellow video terminal (V).
- Set the TV/VIDEO selector on the television to VIDEO.
- If you are connecting the camera to a VCR, set the input selector on the VCR to LINE.

Note:

- If you are going to use the TV as a monitor while you are shooting, remember to keep the TV volume turned down as long as the camera's audio terminals are connected to prevent feedback.

If your TV is already hooked up to a VCR, you can connect the camera to the VCR instead of the TV. Follow the instructions above.

Editing to a VCR

E

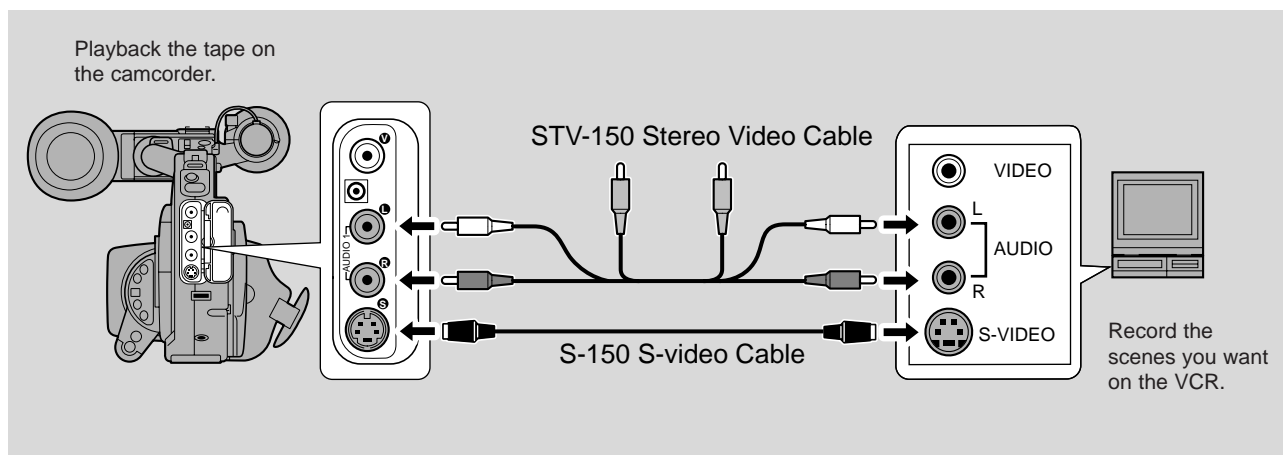

By connecting the camera to another VCR, you can edit your recordings in order to remove unwanted scenes — or combine different shots to create your own video productions.

Preparations

1. Connect the camera to the VCR.

- See “Connections for Playback on a TV screen” on p. 56.

2. Prepare the TV and VCR.

- Turn on the TV and set it to the video channel, or set the TV/VIDEO selector to VIDEO.
- Turn on the VCR, and set its input selector to LINE. Load a blank cassette, and put the VCR in record pause mode.
- See your TV and VCR instruction manuals for details.

3. Turn the camera's POWER dial to VCR, and load your recorded cassette.

Basic Recording

1. Find a point on your recorded cassette slightly ahead of the section you want to copy.
2. Start to play it back while you monitor the picture on the TV.
3. Start recording on the VCR as soon as the section you want to copy appears on the screen.
4. Pause the VCR at the end of the section you want to copy, then stop playback on the camera.
5. Repeat steps 1 to 4 until your edited recording is complete.

Note:

- The quality of the edited tape will be slightly lower than that of the original.

Playback

DV Dubbing (DV terminal conforming to IEEE1394)

E

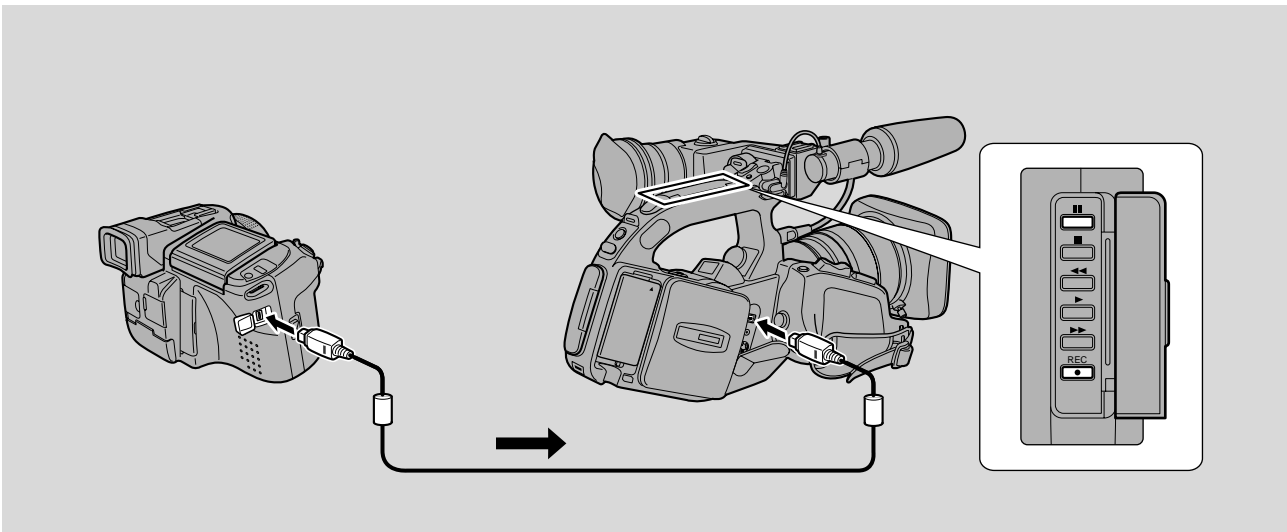

Digital video equipment fitted with this terminal lets you edit, copy and transfer data digitally, with imperceptible loss in image and sound quality. The DV terminal is for both line-in and line-out, since a single DV cable can handle data in both directions.

Use a Canon CV-150F DV cable to connect two digital devices together. When you are recording, make sure you connect the cable to the XL1 before connecting the other end of the cable to the recording device. When you are recording to the XL1, turn the POWER dial to VCR and press its ● (REC) and ■ (pause) buttons down simultaneously (“DV IN” appears in the display when you press “play” on the playback device). Then press its pause button to start/pause recording.

Notes:

- If the cables are not connected properly, the camera displays the caution “CHECK THE DV INPUT”.
- The image displayed by the camcorder that is being recorded to (for example on an attached TV, or in its viewfinder) may become distorted during digital dubbing. The actual recording on the tape, however, is not affected.
- If you press the ● (record) button with the DV cable unconnected, the camera displays the caution “CHECK THE DV INPUT”. An anomalous image may also flash onto the screen.
- Blanks between recordings on the playback tape are recorded as anomalous images on the tape that is being recorded to.
- When operating either camcorder with the DV cable connected do not turn the power off.
- You must attach both digital devices to a power source for digital dubbing to take place.

REMOTE terminal

The REMOTE  terminal allows you to connect the camera to editing equipment. Some buttons on editing equipment may operate differently from those on the camera.

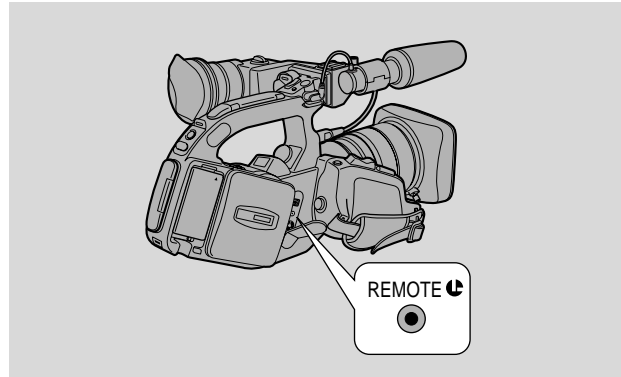

-  (LANC) is a trademark. It stands for Local Application Control Bus System.
- We cannot guarantee the results when connecting to equipment not bearing the LANC  symbol.

Copyright signal

Certain pre-recorded software tapes are copyright protected. If you try to play back such a cassette, “COPYRIGHT PROTECTED PLAYBACK IS RESTRICTED” appears in the display for a few seconds and then the camera displays a blank blue screen; you cannot view the contents of the cassette. If you try to record from such a tape via the digital cable “COPYRIGHT PROTECTED DUBBING RESTRICTED” appears in the display; you cannot record the contents of the tape.

Selecting the Audio Output

E

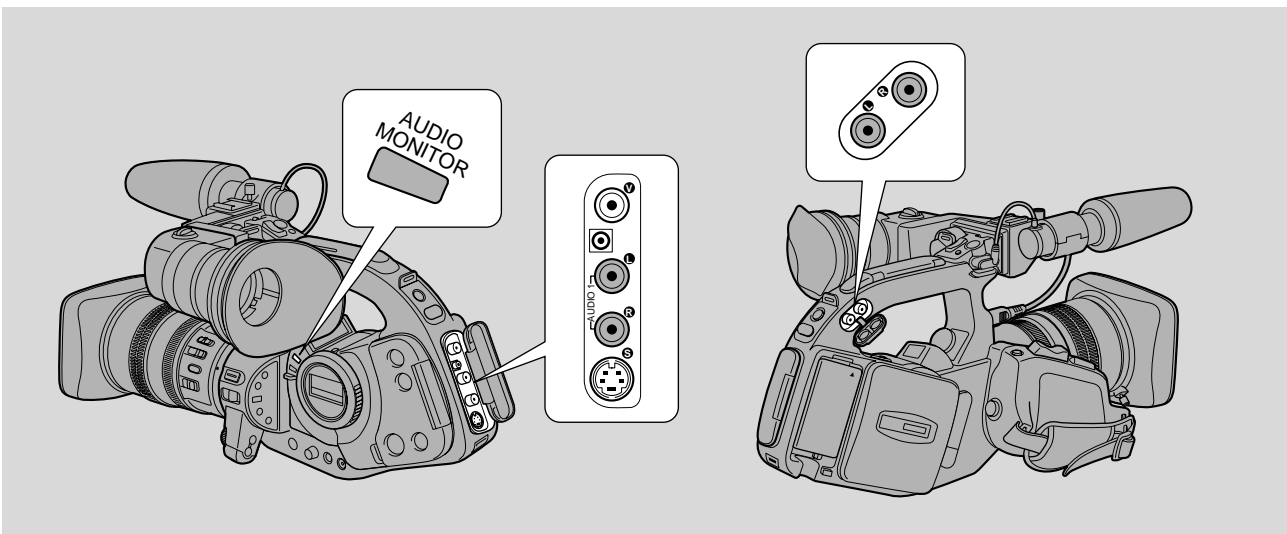

Set the audio output in two main stages: (i) Selecting the audio mix
(ii) Choosing the output channel

(i) Selecting the audio mix

When you play back a tape that was recorded in 12 bit mode, you can select the output: Stereo 1, Stereo 2, or a mixture of the two.

- Audio from the 16 bit mode only contains stereo 1 sound and so you cannot/do not need to select the audio mix. The same is true for the 12 bit stereo 1 mode, unless new sound has been added post-recording. Go directly to stage (ii).
- You only need to release the fixed level (step 2) if your aim is to mix the balance.

1. Set the camera to VCR mode.
2. Release the fixed level (for audio mixing only).

Playback



- a) Open the VCR menu and point the arrow at MIX SELECT.
- b) Select the VARIABLE setting and close the menu.

3. Choose the output.

- a) Press the AUDIO MONITOR button to display “STEREO1”, “STEREO2”, and “MIX”, each in turn.
 - Your choice is selected a few seconds after you last pressed the button.

If you choose “MIX” you can go on to mix the balance.

- Use the ▲ / ▼ cursor keys to choose the mix balance.
(or the ST-1/ST-2 MIX BALANCE buttons on the remote control).



Notes:

- When you have chosen the output, “STEREO1”, “STEREO2”, or “MIX” is shown in the top left of the viewfinder and in the audio LCD panel. If you turn the power off, the output (and display) is set to “STEREO1”.
- You cannot mix the balance without first releasing the fixed level: the camera will show “FIXED” in the viewfinder.

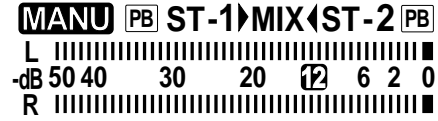

(ii) Choosing the output channel

1. Make sure the camera is set to VCR mode.
2. Open the menu and select the output channel.



L/R (the default setting):

- If the audio mode is 16 bit or 12 bit stereo 1, the audio signal will be sent to the RCA jacks labeled L and R.
- If you chose stereo 1 for the output at stage (i), stereo 1 (L & R) will be sent to the RCA jacks labeled Audio 1 (L & R). In addition, stereo 2 (L & R) will be sent to the RCA jacks labeled Audio 2 (L & R). This gives you four independent audio signals.
- If you chose stereo 2 for the output at stage (i), stereo 2 (L & R) will be sent to Audio 1 (L & R).
- If you mixed the balance at stage (i), the combination of left channels from stereo 1 and stereo 2 will be sent to the left channel of Audio 1 and the combination of the right channels will be sent to the right channel of Audio 1.

L/L

- Only sound from the left channel(s) is output. This output is sent to the RCA jacks (L & R).

R/R

- Only sound from the right channel(s) is output. This output is sent to the RCA jacks (L & R).

L+R/R

- Gives a mono output. Sound from the left and right channels are combined and sent to the left RCA jack(s).

Note:

- The audio sent to connected headphones is the same as sent to the Audio 1 RCA jacks.

Notes on Using the Batteries

E

Charging and recording times

- These times may vary.
- You will get more recording time if you turn the camera off between shots, instead of leaving it in record pause mode.
- Recording time will be shorter than usual at low temperatures. You can use the battery pack between 32° and 104°F (0° to 40°C), but it works best between 50° and 86°F (10° to 30°C).
- If the battery pack starts to give you much less recording time than usual, it has reached the end of its life and must be replaced.

Battery pack	BP-927 (supplied)	BP-941 (option)
Time needed for full recharge	3h 50 min.	4h 40 min.
Maximum recording time	1h 30 min.	2h 15 min.

How much power is left?

The indicator in the display shows you approximately how much charge the battery pack has left:

Notes:

- “CHANGE THE BATTERY PACK” appears in the display for 4 seconds when the power is completely exhausted. The empty battery mark then appears and starts to flash. The power indicator light also flashes.
- The indicator is not constant — different levels will be shown when you subject the battery pack and camcorder to different conditions.
- If you use battery packs other than BP-924 and BP-927, the indicator may not show the correct information.

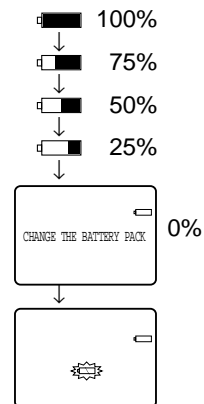

When to recharge

You can recharge a lithium ion battery pack whenever it is convenient. However, as the battery pack will naturally discharge itself over time, it is best to charge it the same day you plan to use it, or the day before.

Taking care of the battery pack

Always attach the terminal cover.

- Do not allow any metal objects to touch the terminals, as this can cause a short circuit and damage the battery pack. Attach the terminal cover whenever the battery pack is not being used.

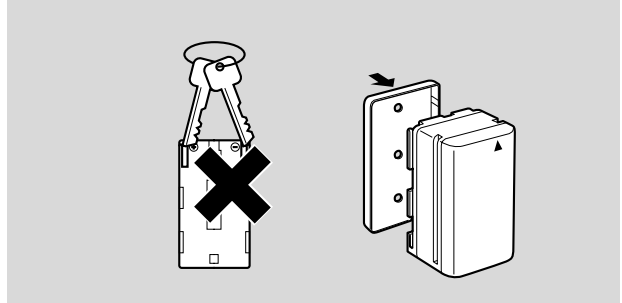

Keep the terminals clean.

- The camera, adapter or battery pack will not work properly if the terminals are dirty. Check them before use, and wipe them with a dry cloth or tissue if necessary.

Storing the battery pack

- If you do not use a battery pack for a period of more than a few months any remaining charge may cause damage to the battery pack, and reduce usage time. To prevent damage therefore, aim to use a battery pack's complete charge before storage.

Installing the backup battery

Pull out the battery holder from the base of the camera, and insert the CR2025 lithium battery with the + side facing upwards. Click the holder back into place.

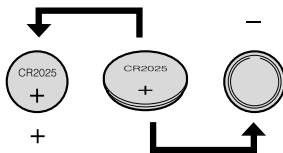

This backup battery allows the camera to remember the date and time and other settings when the main power source is removed. It has a life span of about a year.

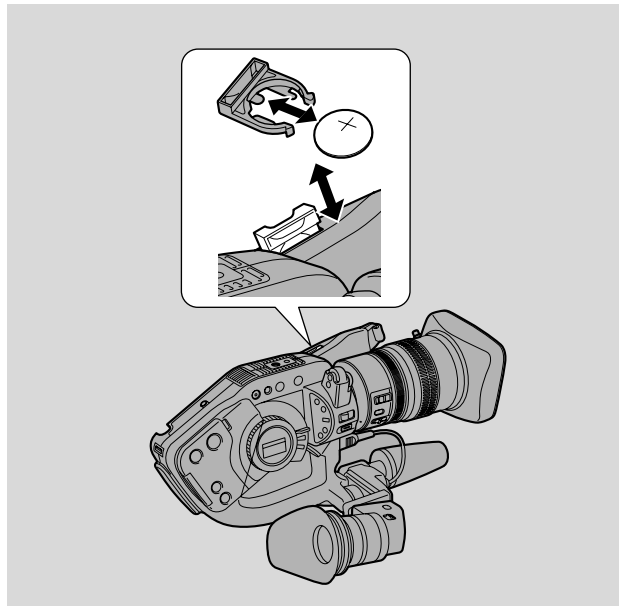

When it needs replacing (or if it has not been installed), the  mark flashes in the display. Remove the old battery by pulling out the battery holder from the base on the camera. Make sure you attach a power source to the camera first, and turn it off using the STANDBY button. This way it will remember your chosen settings when you change the battery.

DANGER!**Treat the battery pack with care.**

- Keep it away from fire (or it might explode).
- Do not expose the battery pack to temperatures greater than 140°F (60°C). Do not leave it near a heater, or inside a car in hot weather, for example.
- Do not try to disassemble or modify it.
- Do not drop or knock it.
- Do not get it wet.

WARNING!

- The battery used in this device may present a fire or chemical burn hazard if mistreated. Do not recharge, disassemble, heat above 212°F (100°C) or incinerate.
- Replace the battery with a Sony, Sanyo or Panasonic CR2025, or Duracell DL2025. Use of another battery may present a risk of fire or explosion.

Cautions:

- Do not pick up the battery using tweezers or other metal tools — this will cause a short circuit.
- Wipe the battery with a clean, dry cloth to ensure proper contact.
- Keep the back-up battery out of reach of children — if it is swallowed, contact a physician immediately, as the battery case may break down and the battery fluids damage the stomach and intestines.
- Do not disassemble, heat, or immerse the battery in water, to avoid the risk of explosion.

Camera Holding Styles

Choose the grip

- You can grip the camera from the side grip, or top handle.
- Either gripping position allows you to start/stop recording, take a “photo” and zoom in and out.
- Lock the top controls to prevent accidental operation by flicking across the HOLD lever.

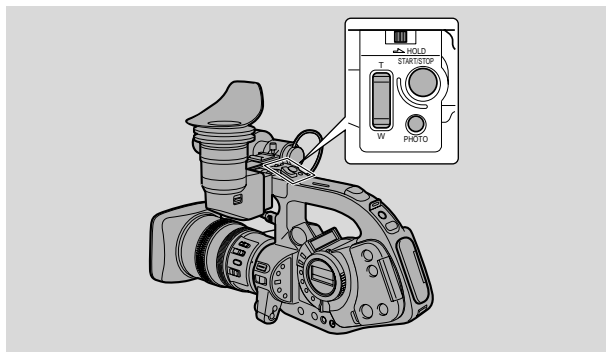

E

Standard holding style

For maximum stability, place your right hand through the side grip belt and keep your right elbow pressed against your body. Rest the rear of the camera against the front of your shoulder and then support the lens with your left hand.

Low-angle recording

Grip the camera using the top handle and steady the lens with the other hand.

Using a tripod

To prevent any unwanted movement, mount the camera on a tripod and operate it from the remote control.

- Be careful not to leave the viewfinder in bright sunlight or it may damage the LCD. (the light is concentrated by the viewfinder lens.) Either turn the EYE POINT SELECT switch to the FAR setting, or change the angle of the viewfinder to move it out of direct sunlight.
- Make sure the fastening screw of the tripod is no longer than 3/16 inch (5.5 mm), or it may damage the camera.
- Do not attach a tripod to the socket meant for the shoulder pad (the socket closest to the rear of the camera).

Maintenance

E

Cautions

Avoid high temperatures and high humidity.

- Do not leave the camera inside a car in hot weather, for example.
- Be careful of heat radiating from video lighting equipment.
- Do not take the camera into a humid room.

Avoid sudden changes in temperature.

- If you take the camera from a cold place to a warm place, condensation may form on the lens and internal parts (see p. 68).

Do not point the lens or viewfinder at strong light sources.

- Never point it at the sun, and do not leave it aimed at a bright subject.
- Be especially careful when leaving the camera on a tripod.

Avoid magnetic or electric fields.

- Do not use the camera close to TV transmitters, portable communication devices or other sources of electric or magnetic radiation. They may cause picture interference, or permanently damage the camera.

Do not expose the camera to water.

- Cover the camera when you are recording in rain or mist.
- There is a risk of electric shock if water gets inside the camera — contact qualified service personnel as soon as possible.

Protect the lens.

- Sand and dust can damage the lens — be especially careful on windy days.

Handle the camera gently.

- Vibration or shock can cause damage.
- Do not use the viewfinder unit or microphone as a carrying handle.
- Do not swing the camera around when carrying it by the handle; knocking the camera against things may cause it to malfunction.

Do not disassemble the camera.

- This is very dangerous as there is a risk of electric shock — if the camera does not function properly, take it to qualified service personnel.

Storage

If you do not intend to use the camera for some time, store it in an area which is free of dust and moisture, and where the temperature is no higher than 86°F (30°C). After storage, check each part and function of your camera to make sure everything is still working properly.

Note:

- These cautions also apply to accessories such as battery packs and cassettes.

Maintenance

E

Viewfinder (removal)

- You may wish to remove the viewfinder for storage or transport. Remove the viewfinder cable from the socket at the front of the camera body. Loosen the locking screw that holds the unit in place and slide the viewfinder unit off the bracket.

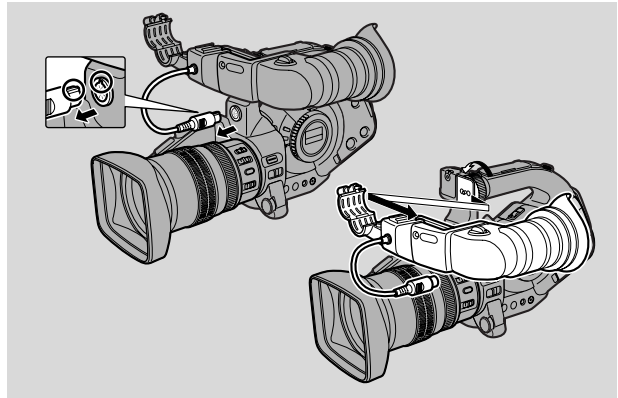

Viewfinder (brightness)

- Adjust the brightness of the display by turning the BRIGHT screw. You can reveal the screw on the under side of the viewfinder by pulling back the small screw cover.

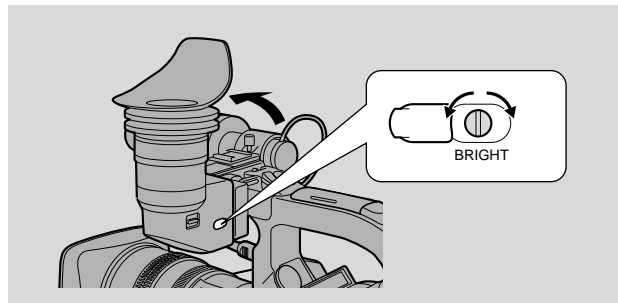

Camera body and lens

- Use a soft, dry cloth to clean the camera body or lens. Never use chemically treated cloth or volatile solvents such as paint thinner.

Video heads

- When mosaic-like noise appears on the playback picture, the video heads may be dirty. When the video heads are badly contaminated, the camera may show a blank blue screen.
- Clean the video heads using Canon's DVM-CL Digital Video Head Cleaning Cassette. If the "noise" remains, repeat the cleaning (up to maximum of five times).
- Do not use a wet-type cleaning cassette, as this can cause damage.



Using the camera abroad

Power sources

- You can use the compact power adapter to operate your camera and charge battery packs in any country where the electricity supply is between 110 and 240 V AC, 50/60 Hz. Contact your Canon dealer for information about plug adapters for overseas use.

TV playback

- Although you can always play back your recordings in the viewfinder, your camera can only be connected to TVs which use its NTSC system. This TV system is used in the following countries: American Samoa, Bahama, Barbados, Bermuda, Bolivia, Canada, Chile, Columbia, Costa Rica, Cuba, Ecuador, El Salvador, Guam, Guatemala, Greenland, Haiti, Honduras, Jamaica, Japan, Korea, Mexico, Micronesia, Myanmar, Nicaragua, Panama, Peru, Philippines, Puerto Rico, Saint Lucia, Surinam, Taiwan, Trinidad and Tobago, USA, Venezuela.

Condensation

Condensation may form on the camera when it is moved from a cold place to a warm place. Using the camera while condensation is present can damage both the tape and the camera.



Condensation may become a problem:

- When you bring the camera from a cold place to a warm room
- When a cold room is heated rapidly
- When the camera is left in a humid room
- When the camera is taken from an air-conditioned room to a warm, humid place

Protecting the camera from condensation

- Before you bring the camera to a warm or humid place where condensation is likely to be a problem, unload the cassette and put the camera in a plastic bag. Wait until the camera reaches room temperature before you take it out of the bag.

What happens when condensation is detected

- “CONDENSATION HAS BEEN DETECTED” is displayed for approximately 4 seconds. Then, the power indicator flashes and the  mark flashes in the viewfinder. If there is a cassette in the camera, it stops automatically and “REMOVE THE CASSETTE” is displayed for approximately 4 seconds and then EJECT flashes in the viewfinder (without a cassette,  flashes instead).
- The camera may not detect the condensation immediately — the condensation warning may not start flashing for 10 to 15 minutes.
- You cannot load a cassette when condensation is detected.

What you should do

- Remove the cassette, leave the cassette compartment open, and turn the camera off.
- Leave it in a dry place until the condensation evaporates. After the condensation warning stops flashing, wait at least another hour before trying to use the camera.

Troubleshooting

Refer to this checklist first if you have any problems with your camcorder. Possible explanations are given for each problem on the list — turn to the page numbers in brackets for more information.

E

Make sure that the camera is properly connected if you are using it with a TV or VCR. Consult your dealer or service outlet if problems persist.

Recording/Playback

Problem

Cause and/or what to do about it

? Nothing happens when I press the buttons.

- The camera is not switched on (p. 23, 51).
- The cassette is not loaded or is set for erasure prevention (p. 15-16).
- The tape has reached the end.
- The battery pack is exhausted or not properly attached (p. 13, 14, 62).
- The function cannot be used in that recording program (p. 32).
- The top controls are locked by the hold lever (p. 65).

? The camera turned itself off.

- The camera was in record pause mode for more than about five minutes (p. 23).
- The battery pack is exhausted (p. 14).

? The start/stop button doesn't work.

- The POWER dial is not set to a recording program (p. 32).
- The cassette is not loaded or is set for erasure prevention (p. 15-16).
- The tape has reached the end.

? There's no picture in the viewfinder.

- The POWER dial is not set to a recording program (p. 32).
- The camera has not been used for a long while, it is not a malfunction. Switch off the camera. Take off the battery and reattach it. Then switch on the camera again.

? There's a blank blue screen in the display.

- You are attempting to play back or record from a copyright protected cassette (p. 59).
- The tape heads are badly contaminated (p. 67).

? The camera won't focus.

- The camera is on manual focus (p. 44).
- The viewfinder lens needs adjusting (p. 11).
- The lens is dirty (p. 67).

E**Note:**

Some subjects are not suitable for autofocus. In these situations, you will often get better results using manual focus (see p. 44).

- Horizontal stripes
- Many subjects at different distances
- Behind glass
- Without much contrast (e.g. a white wall)
- Reflective surfaces (e.g. shiny car surfaces)
- Fast moving objects
- Slanted subjects
- Dark subjects
- Night scenes

Recording/Playback (Contd.)

Problem**Cause and/or what to do about it**

? Some/all of the digital effects don't work, or can't be set.

- There are a few restrictions on using the digital effects. Refer to the notes on p. 41.

? The ► (play) button doesn't work.

- The POWER dial is not set to VCR (p. 51).
- The cassette is not loaded (p. 15).
- The tape has reached the end.

? There's a bright stripe on the screen.

- When recording in dark places a bright light in the scene may cause a vertical light bar ("smear") to appear. This is a normal feature of camcorders.

? The playback picture is rough (with mosaic-like noise).

- The video heads need cleaning (p. 67).

? There's no picture on the TV screen, even though the tape is moving.

- The video heads need cleaning (p. 67).
- The TV/VIDEO selector on the TV isn't set to VIDEO (p. 56).

Problem**Cause and/or what to do about it**

? The wireless controller doesn't work.

- The remote sensor is turned off (p. 21).
- The batteries are dead or not inserted.

? The tally lamps don't flash.

- They are turned off (p. 21).

? There are air bubbles inside the lens.

- This is unlikely, but may happen if you use the camera in places where the air pressure is low, in an airplane for example. The bubbles will disappear a week or so after you return the camera to normal atmospheric pressure.

? The camera malfunctions.

- External interference may cause the camera's microprocessor to malfunction temporarily. If random letters appear in the display or if normal operation is interrupted, remove and then replace the power source (and if necessary, the back-up battery).

? The viewfinder displays are unclear.

- The EYE POINT SELECT switch is set to FAR (p. 11).
- The viewfinder focusing ring needs adjusting (p. 11).

? The DV cable is connected correctly, but there's nothing in the display.

- Remove the cable and then reconnect it or turn the power off and back on again.

? The lens is attached, but LENS continues to flash in the viewfinder.

- Make sure the lens has clicked fully into position. If necessary, turn the POWER dial to OFF, remove the lens and retry (p. 9).

About the LCD Viewfinder

Liquid Crystal Viewfinders use extremely high-precision technology, but there will be pixels which do not light up or which are continuously lit. This is not an error and will not affect the recording.

About the CCD

Due to the construction of the CCD, in low-light recording using the slow shutter or gaining up, small specks of light may become visible in the viewfinder. In such cases, increase the shutter speed, reduce the gain or use an additional light source such as a video light.

The XL1 System Diagram (Availability differs from area to area)

E

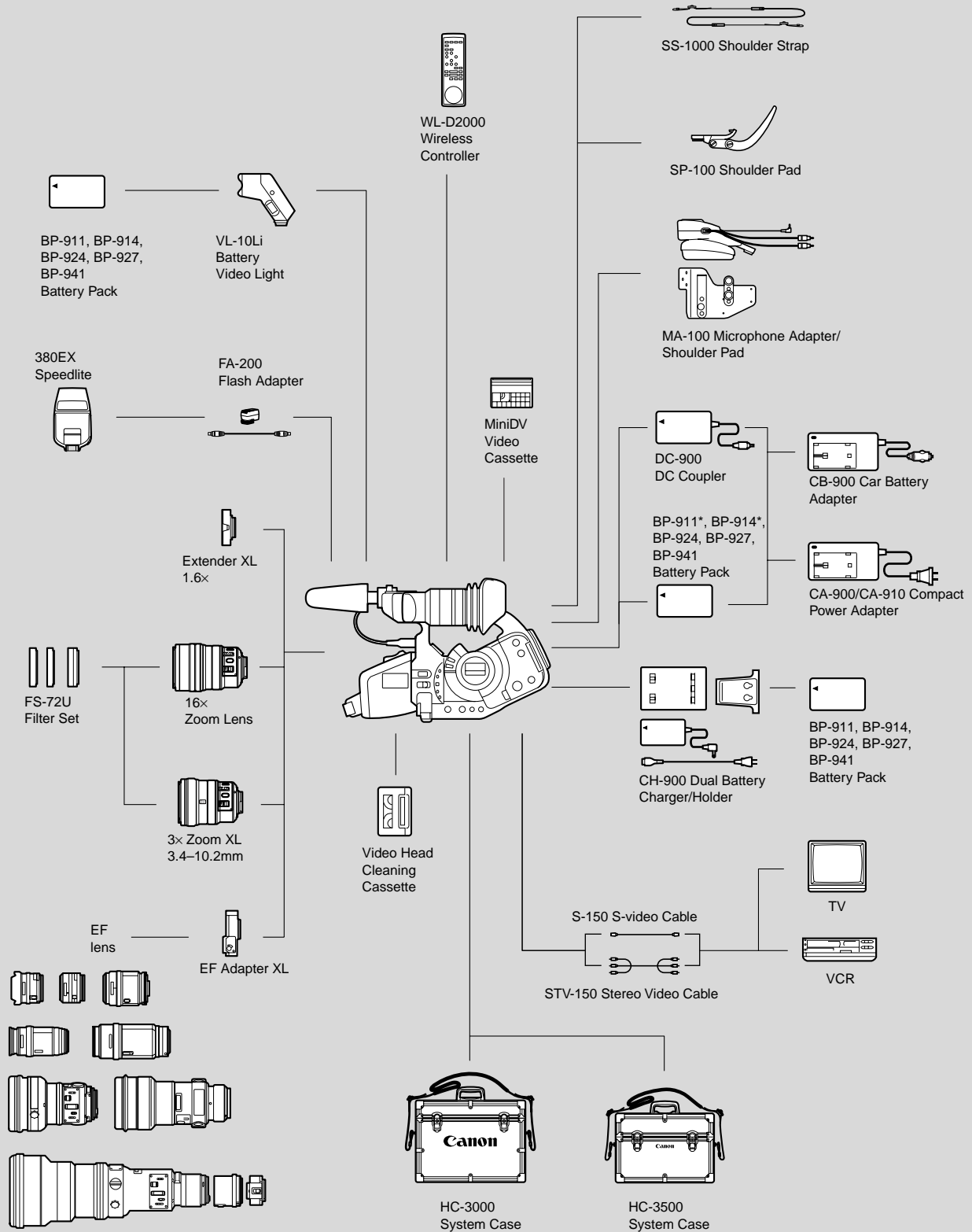

* The power remaining indicators may not show the correct information if used with the XL1.

Additional Information

Optional Accessories

Battery Packs

The BP-927 is supplied as standard. It is also available as an optional accessory.

The optional BP-941 provides 50% more recording time than the BP-927.

BP-927

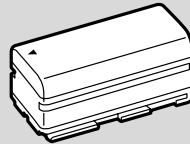

BP-941

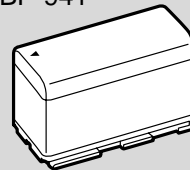

E

CB-900 Car Battery Adapter

Power your camera, or recharge battery packs on the move. The car battery adapter plugs into your car's cigarette lighter socket and runs off a 12-24V DC negative ground battery.

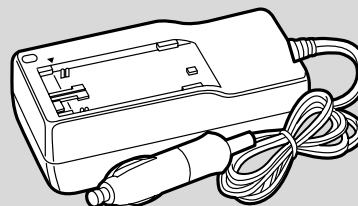

FS-72U Filter Set

Ultraviolet, neutral density and circular polarizing filters to help you take control of difficult lighting conditions.

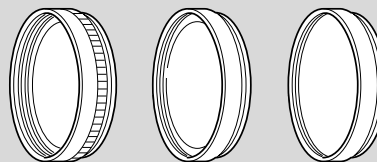

HC-3000 System Case

A solid, lockable case that provides safe and stylish protection for the camera during transportation and storage.

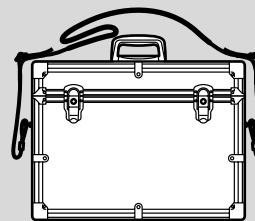

HC-3500 System Case

Small enough to take onto an aircraft as carry-on luggage (XL1 body with a lens, power supply and an extra lens).



MA-100 Microphone Adapter/Shoulder Pad

Allows you to use a mic. that has XLR connectors with the XL1, plus makes shoulder-mounted shooting possible. In addition, use it to attach a wireless microphone receiver or to hold the separately available CH-900 Dual Battery Charger/Holder.

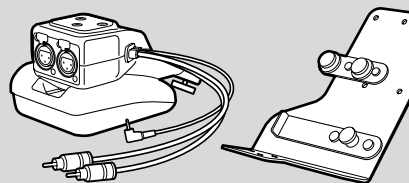

Additional
Information

E**FA-200 Flash Adapter**

Facilitates use of a Canon Speedlite 380EX with the XL1.

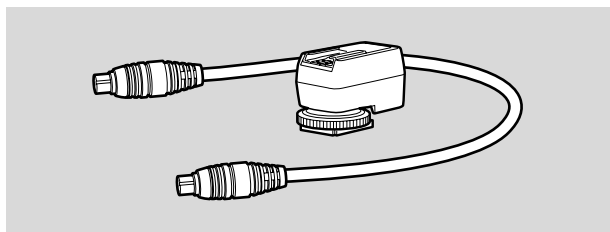
**3× Zoom XL 3.4–10.2mm (available Summer '98)**

A super wide-angle lens that gives a range of 24 – 72 mm (35mm film equivalent).

Extender XL 1.6×

Attach this extender between a Canon XL lens and the XL1 to boost the focal length of the lens by 1.6×

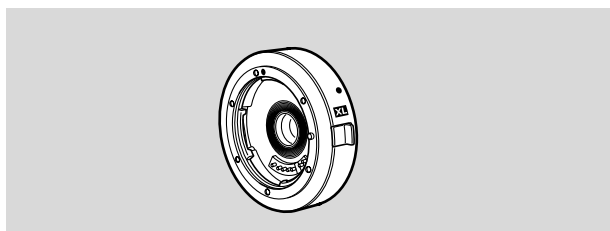
**EF Adapter XL**

This allows you to attach Canon EOS lenses to the XL1. The difference in size between the XL1's 1/3" CCD's and 35mm film means that the effective focal length of still camera lenses is multiplied by 7.2×. A 300mm lens, for example, is transformed into an incredible 2,160mm super telephoto.

- Consult your local service outlet to make sure there are no compatibility problems with your chosen lens.

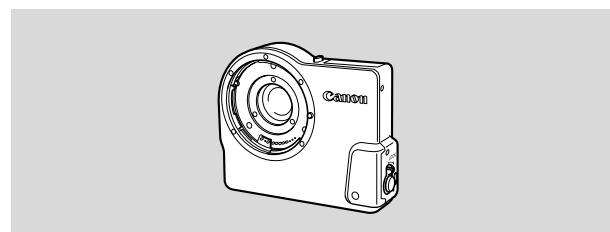
**VL-10Li Battery Video Light**

This compact yet powerful video light can be used for both indoor and outdoor shooting.

- Lithium ion battery packs can be used to power the light. Approximate usage times are as follows:

BP-911	45 min	BP-924	90 min
BP-914	50 min	BP-927	100 min
BP-941	160 min		

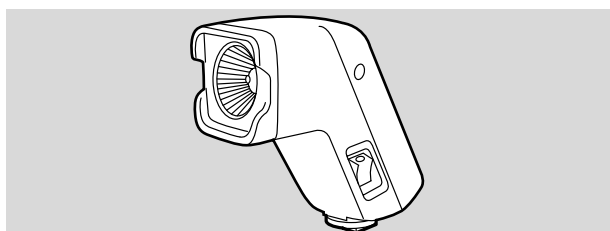

CH-900 Dual Battery Charger/ Holder

This holds two battery packs and can charge them both consecutively.

It can then be connected directly to the XL1 using its DC Coupler to give twice the playback time. It can also make use of the high performance battery pack BP-927, to give up to 3hrs. recording time.

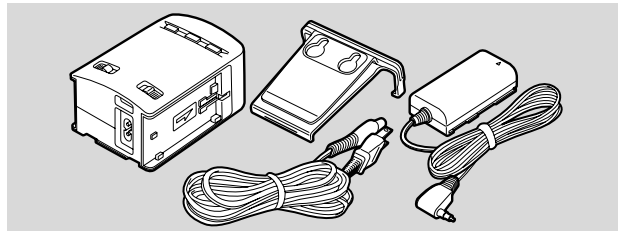

380EX Speedlite

Attaches to the XL1 to give SLR-style flash photography (the optional FA-100 Flash Adapter is also necessary).

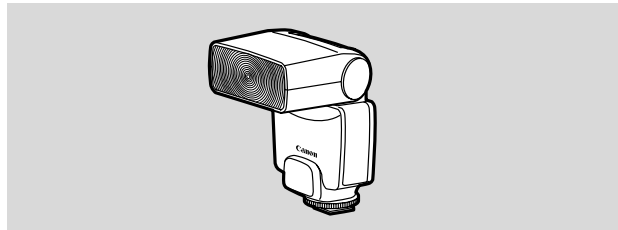

This mark identifies genuine Canon video accessories. When you use Canon video equipment, we recommend Canon-brand accessories or products bearing the same mark.

Provided accessories:

16x Zoom Lens	D51-0310-201
Stereo Microphone	D84-0110-000
WL-D2000 Wireless Controller	D83-0432-000
CA-900 Compact Power Adapter	D85-0492-201
CA-910 Compact Power Adapter	D85-1022-201
DC-900 DC Coupler	D85-0630-201
BP-927 Battery Pack	D85-0852-201
SP-100 Shoulder Pad	D87-0040-201
SS-1000 Shoulder Strap	D81-1220-000
S-150 S Video Cable	D82-0330-202
STV-150 Stereo Video Cable	D82-0490-201
Lens Hood	YG9-5739-000
Lens Cap	YF1-0008-000
Body Cap	DA1-8472-000
Dust Cap	YA1-1715-000
Lens Soft Case	YA1-1717-000

Optional accessories:

CB-900 Car Battery Adapter	D85-0502-201
CH-900 Dual Battery Charger/ Holder	D85-0772-201
MA-100 Microphone Adapter/ Shoulder Pad	D84-0100-201
HC-3000 System Case	D81-1181-201
FS-72U Filter Set	D53-0030-202
Extender XL 1.6x	D56-0080-201
EF Adapter XL	D56-0070-201
VL-10Li Battery Video Light	D86-0081-201
JR7.2V 10WF Halogen Bulb	DY4-4530-000
FA-100 Flash Adapter	D82-0540-201
380EX Speedlite (Flash Unit)	C50-0721-201
DVM-CL DV Cleaning Cassette	D36-0032-201

Finding Your Way Around the XL1

E

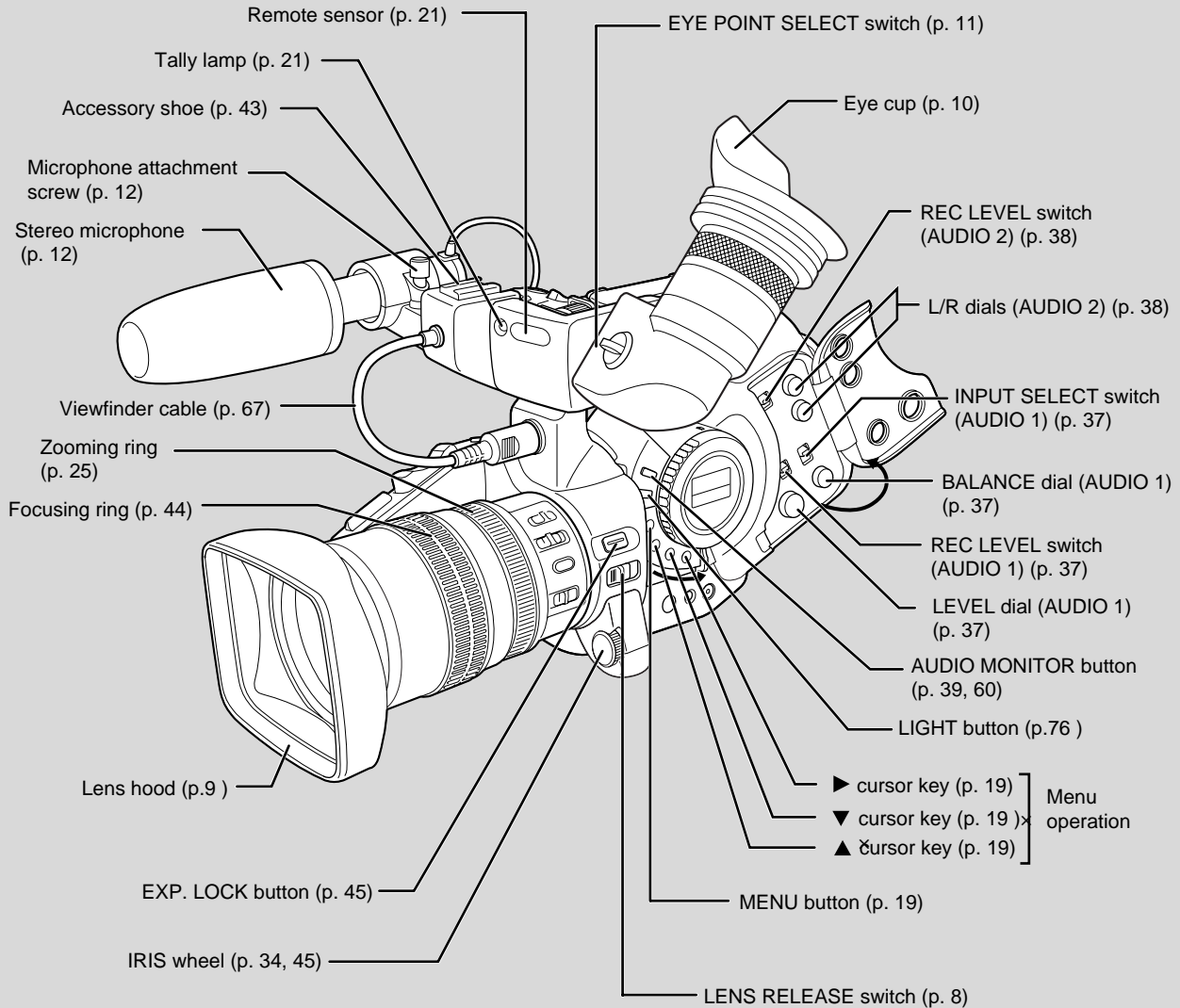

Additional Information

Light Button

Push the LIGHT button to illuminate the main and audio panels for approximately 10 seconds. If you press and hold the button for at least 3 seconds, the panels remain illuminated until you press the button once more to turn the backlight off.

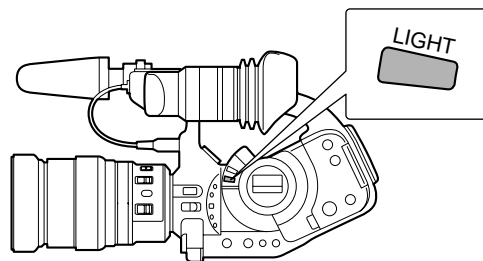

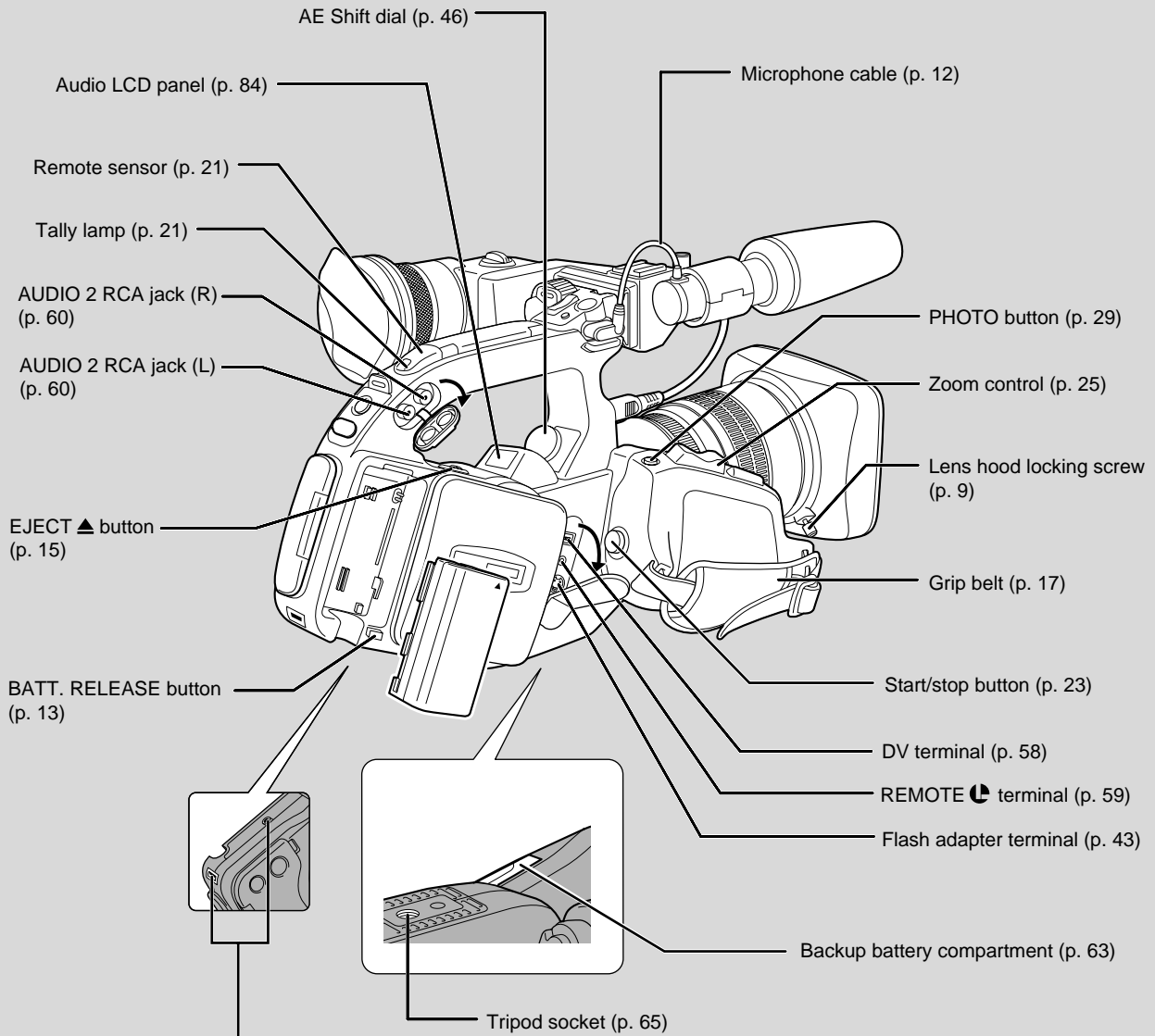

Socket for attaching the SP-100 Shoulder Pad or MA-100 Microphone Adapter/Shoulder Pad. Do not attach a tripod to this socket.

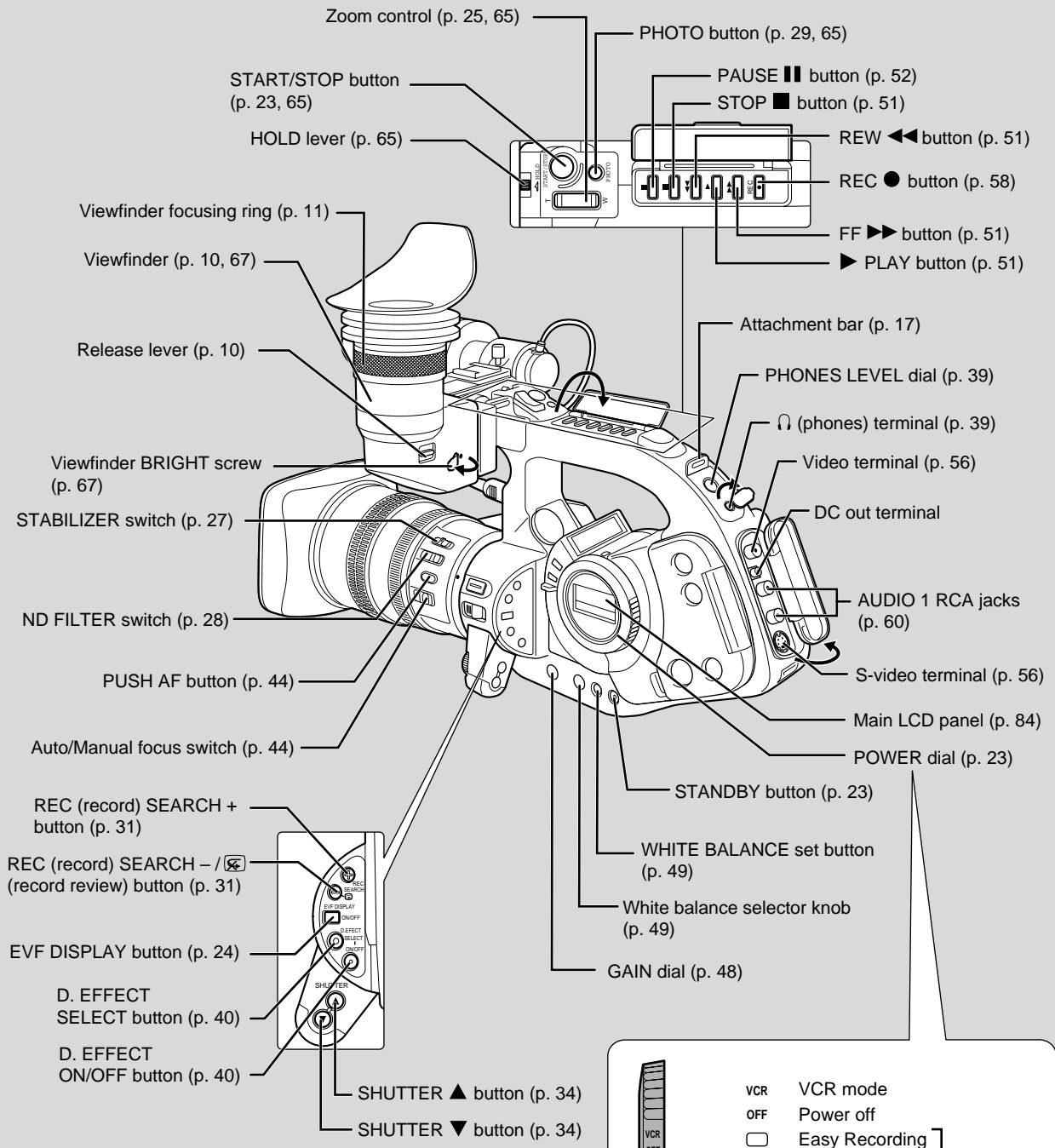

Additional Information

	VCR	VCR mode	Recording programs
	OFF	Power off	
		Easy Recording	
	A	Auto	
	Tv	Shutter-Priority	
	Av	Aperture-Priority	
	M	Manual	
		Spotlight	
	POWER		

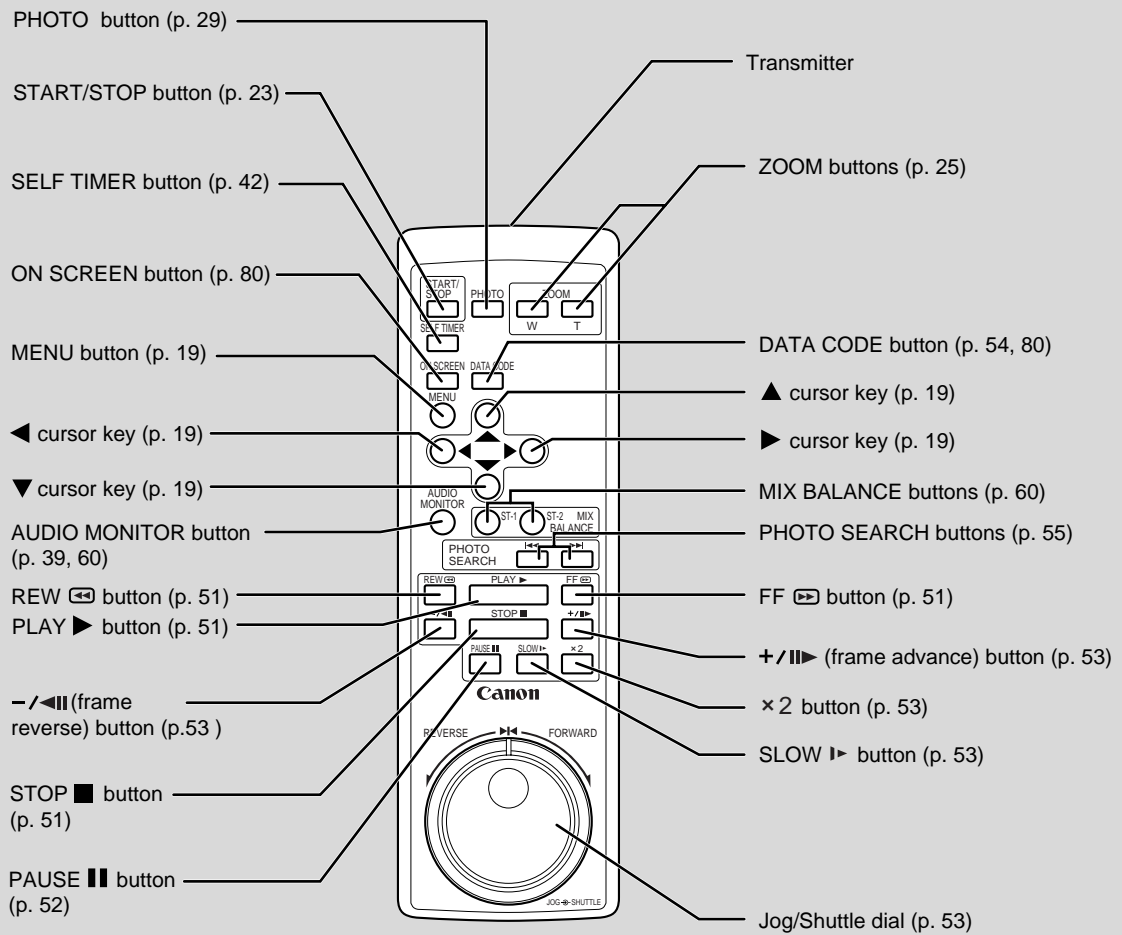



Screen Displays

E

To display the date and time on a connected TV, press the wireless controller's DATA CODE button when the camera is in VCR mode with a tape loaded.

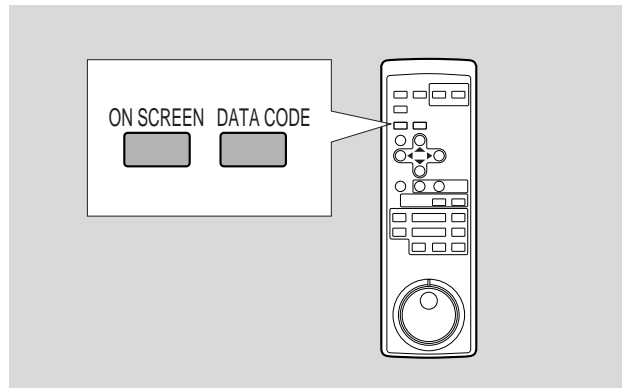
Press the wireless controller's ON SCREEN button to see the other displays on the TV screen. (The displays appear white on-screen.) They will not be added to any recordings you make with the camera.



 indicates a flashing display.

Record pause mode (p. 23) 

Recording (p. 23) 

The backup battery is not properly installed, or needs replacing (p. 63). 

Shows how much battery power remains (p. 62). 

The battery pack is exhausted (p. 14, 62). 

No cassette is loaded, or it is set for erasure prevention (p. 16). 

Remaining tape (Green: more than 5 mins. Yellow: less than 5 mins. Red: final few secs). 

...finally, it tells you when you have completely run out of tape. 

The camera is ejecting the tape (p. 15). 

The safety mechanism is activated. Unload the cassette and turn the camera off. Turn it on again and reload the cassette. 

Recording mode (p. 24) 

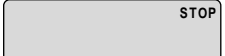
Playback is stopped (p. 51). 

Normal playback (p. 51) 

Fast forward (p. 51) 

Rewind (p. 51) 

Fast forward playback (p. 52) 

Rewind playback (p. 52) 

Frame advance playback (p. 53) 

Frame reverse playback (p. 53) 

Additional Information

Playback pause (forward and reverse) (p. 52)



Slow playback (forward and reverse) (p.53)

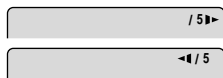

×2 playback (forward and reverse) (p. 53)

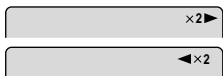

×1 playback (forward and reverse) (p. 53)



Photo Search (p. 55)

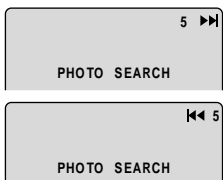
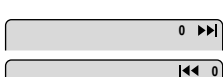
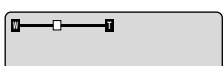

Photo search is complete



Zoom display (p. 25):
Optical zoom



Optical plus digital zoom

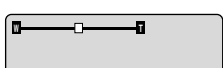

Zoom in

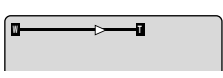

Zoom out

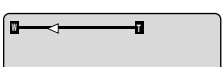

Camera menu (p. 18)

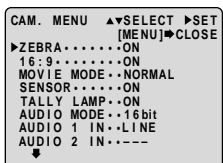

VCR menu (p. 18)

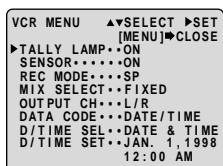

The remote sensor is turned off (p. 21).



Self-timer countdown (p. 42)

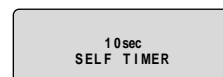

Audio mode (p. 36)

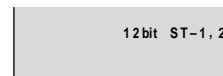

Data code (p. 54)



The camcorder does not have a lens attached

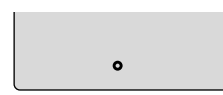

Photo mode (p. 29)

- Setting the AF/AE mark flashes white



- AF/AE locked mark lights up green



- Timer



Movie mode (p. 30)



Recording programs (p. 32).

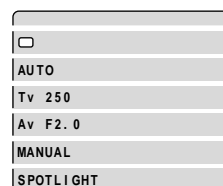

Additional Information

E

Flash is charging
⚡ mark flashes white (p. 43)
or charged



⚡ mark lights up green (p. 43)



Manual exposure display
(p. 45):
Exposure locked

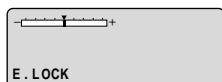

Brighter than standard exposure
level

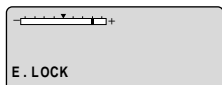

Darker than standard exposure
level

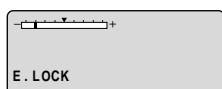

Manual setting of shutter speed,
F number



The iris is closed



ND Filter (p. 28)



Manual focus is selected
(p. 44).



White balance is set manually
(p. 49).



- Outdoor mode



- Indoor mode



The 16:9 effects: the display
flashes when the effect has been
selected, and appears steadily
when it is activated (p. 41).

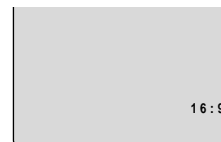

Digital effects: the display
flashes when the function has
been selected and appears
steadily when it is activated
(p. 40).

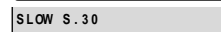

Slow shutter effects can not be
selected at this time (p. 35)

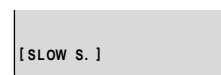

The camcorder is being recorded
to via the DV terminal (p. 58)



Gain (p. 48)



Audio output (p. 60)



Mix balance (p. 60)

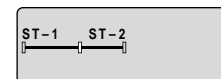

Mix select has not been released
at the menu (p. 61)



Condensation warning (p. 68)



Additional
Information

Time Code



This records counter information, including hour, minute, second, and frame number on a special data code area on the tape itself. It is reset automatically when a new tape is loaded.

Recording reminder

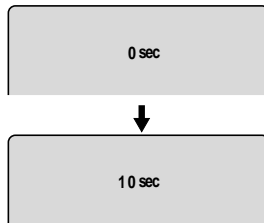

When you start recording, the camera counts from 0SEC to 10SEC. Shots which are shorter than 10 seconds may be difficult to edit later. On the other hand, if you are not planning to edit the recording, remember that a shot which does not contain action should generally last no longer than 10 seconds.

Caution phrases

The camera displays various caution phrases — they appear for 4 seconds before disappearing.

Appears each time you turn the power on, until you set the date and time (p. 22).

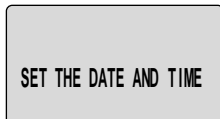

Refer to pages 8-9.

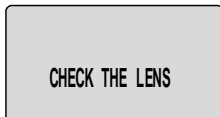

Refer to page 23.

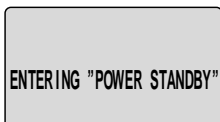

Appears when the battery pack is exhausted (p. 14, 62).

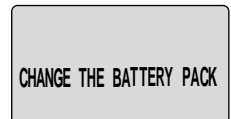

Appears when the tape has reached the end.



Refer to page 16.



Appears when you press the (record) button if the DV cable is not connected properly (p. 58).

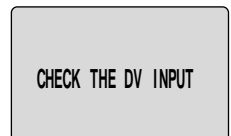

Refer to page 68.



Appears as a warning to protect the tape and also when condensation is detected. Remove the tape as soon as possible after the camera has displayed the caution.



Refer to page 59.



Refer to page 59.



Main LCD panel

Recording mode
(p. 24)

Time code
(p. 83)

Cassette:
set for erasure
prevention or not
loaded (p. 16)

Tape has
reached the end
(p. 83)

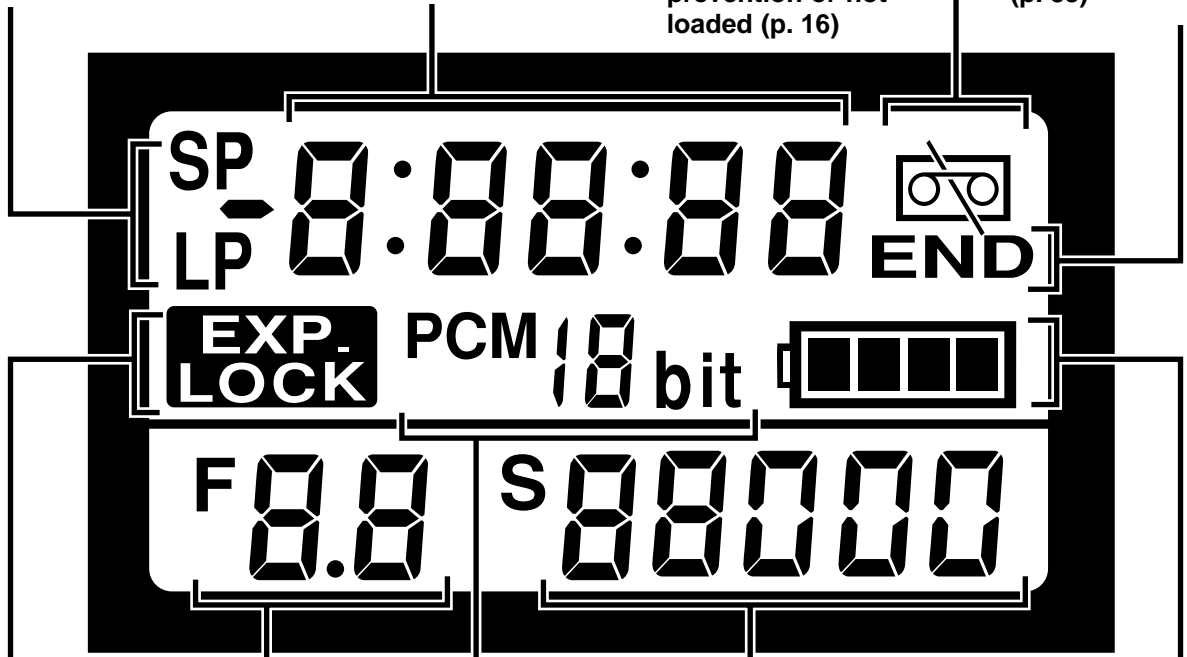

Exposure lock
(p. 45)

F number
(aperture size)
(p. 34)

Audio mode
(p. 36)

Shutter speed
(p. 34)

Remaining battery
power (p. 62)

Audio LCD panel

Manual recording
level (p. 37)

Audio mix (p. 60)
• When only **PB** is shown = 16-bit mode

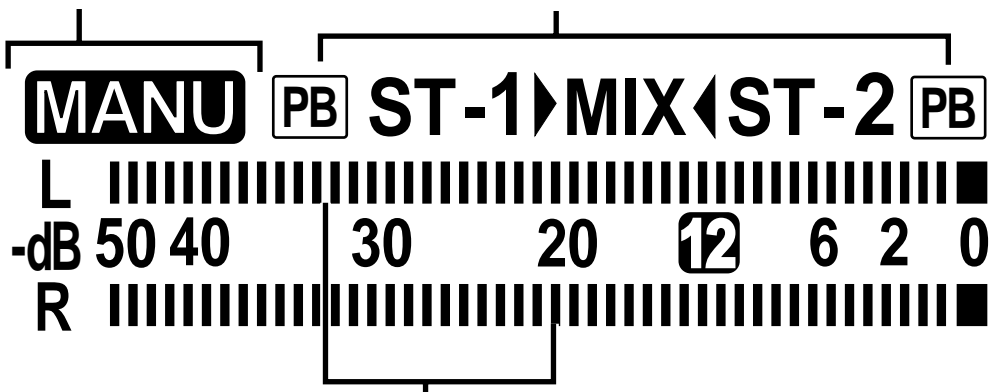

L, R Recording levels
(p. 38)

Specifications

XL1

Power Supply (rated): 7.2 V DC
Power Consumption (while recording, AF=ON):
9.5 W (Approx., recording with the AF turned on)
Television system:
EIS standard (525 lines, 60 fields) NTSC color signal
Video recording system:
2 rotary heads, helical scanning system
DV system (Consumer digital VCR SD system)
Digital component recording
Audio recording system: PCM digital sound:
16 bit (48kHz/2ch), 12 bit (32kHz/2 from 4ch),
12 bit (32kHz/4ch simultaneous)
Image sensor: 3CCD 1/3" Pixel Shift (charge coupled device) 270,000 pixels
(250,000 effective pixels)
Tape format: Videocassettes bearing the  mark.
Tape speed:
SP: 3/4 ips (18.81 mm/s);
LP: 1/2 ips (12.56 mm/s)
Maximum recording time:
SP: 60 minutes (with a 60 min. cassette);
LP: 90 minutes (with a 60 min. cassette)
Fast forward/rewind time:
2 mins 50 sec. (with a 60 min. cassette)
Lens mount: XL Interchangeable lens system
(16x zoom [supplied]: f/1.6–2.6, 5.5–88mm)
Focusing system: TTL autofocus, manual focusing possible
Minimum focusing distance:
13/16 inch (2cm) on maximum wide angle;
telephoto end: 3ft 4in (1m)
Maximum shutter speed:
1/15,000 sec
Minimum illumination: 2 lx (using XL
5.5–88mm lens, and slow shutter at 1/8 of a second)
Recommended illumination:
More than 100 lx
Filter diameter: 72mm (XL lens)
Viewfinder: 0.7-inch, color LCD
(approx. 180,000 pixels)
Microphone: Stereo electret condenser microphone

DV Terminal: Special 4 pin connector (based on IEEE1394)

Output level:

Video terminal: RCA jack, 1 Vp-p/75Ω unbalanced, synchronized load

S-video terminal: 4 pin mini DIN, 1 Vp-p (Y signal), 0.286 Vp-p (C signal)

Audio terminal: RCA jack (L, R), 2 sets 4dBm (47kΩ load)/3kΩ or less, unbalanced

Input level:

Audio terminal: RCA jack (L, R), 2 sets

-11dBV/47kΩ (LINE), unbalanced

-35dBV/600Ω (MIC ATT), unbalanced

-55dBV/600Ω (MIC), unbalanced

Microphone terminal: φ3.5mm stereo mini-jack, -59dBV (with 600Ω mic)/600Ω

Operating temperature range:

32°–104°F (0°–40°C)

Dimensions: 8 3/4 × 8 7/16 × 16 5/16 in
(223 × 214 × 415 mm)

Weight (not including lens and battery pack):

3 lbs 12 oz approx. (1.7kg)

(fully loaded):

6 lbs 3 oz approx. (2.86kg)

BP-927 Battery Pack

Battery type: Rechargeable lithium ion battery

Rated voltage: 7.2 V DC

Operating temperature: 32°–104°F (0°–40°C)

Battery capacity: 2,700 mAh

Dimensions: 1 1/2 × 1 5/8 × 2 13/16 in
(38.2 × 39.0 × 70.5 mm)

Weight: 6 1/2 oz (185 g)

Weight and dimensions are approximate

Errors and omissions excepted.

Subject to change without notice.

Canon is a trademark of Canon Inc.

E

Index

E

- A** Abroad, Using the Camera, 67
 - Accessories, 6, 73
 - Adapter, AC, 13
 - AE Programs, 32
 - AE Shift, 46
 - Audio Input, 37
 - Audio Output, 60
 - Audio/Video Terminals, 56
 - Auto, 33
 - Autofocus, 44
- B** Backup Battery, 63
 - Basic Recording, 23
 - Battery Pack, 14
- C** Cables, 6, 56
 - Cassettes, 15
 - Charging the Battery Pack, 14
 - Choosing a Recording Program, 32
 - Cleaning the Camera, 67
 - Condensation, 68
 - Connection to TV or VCR, 56
- D** Date and Time, 22
 - Displaying Data Code, 54
 - DC Coupler, 13
 - Digital Video, 7
 - Digital Zoom, 26
 - DV Terminal, 58
- E** Easy Recording, 32
 - Editing, 57
 - Edit Search, 52
 - Exposure, 45
- F** Fade, 40
 - Fast Forward, 52
 - Feedback, 56
 - Finding Your Way Around the XL1, 76
 - Flash photography, 43
 - F Number, 34, 45
 - Focusing, 44
 - Frame Mode, 30
- G** Gain, 48
 - Grip Belt, 17
- H** Head Cleaning, 67
 - Headphones, 39
- I** Image Stabilizer, 27
 - Introducing the XL1, 7
 - Iris Wheel, 34, 45
- L** LANC, 59
 - LCD Panels, 84
 - Lens Cap, 17
 - Lens Hood, 9
 - Light, 76
 - Loading Cassettes, 15
 - Low-angle Recording, 65
 - LP Mode, 24
- M** Maintenance, 66
 - Manual Focus, 44
 - Manual Recording Program, 33
 - Menus, 18
 - Microphone, 12
 - Mix Balance, 60
 - Movie Mode, 30
- N** ND Filter, 28
- O** Optical Image Stabilizer, 27
 - Optional Accessories, 73
- P** Photo Mode, 29
 - Photo Search, 55
 - Playback, 51
 - Playback Connection, 56
 - Playback Pause, 52
 - Power Adapter, 13
 - Powering Your Camcoder, 13
 - Problems, 69
 - Push Autofocus, 44
- R** Recharging the Battery Pack, 62
 - Recording, 23
 - Recording Level, 37, 38
 - Recording Programs, 32
 - Record Pause Mode, 23
 - Record Review, 31
 - Record Search, 31
 - Remote Control, 20
 - Remote Sensor, 21
 - Rewind, 51
- S** Screen Displays, 80
 - Self-Timer, 42
 - Shoulder Pad, 17
 - Shoulder Strap, 17
 - 16:9, 41
 - Shutter Speed, 34, 45
 - Slow Shutter, 35
 - Sound Check, 39
 - Specifications, 85
 - Speedlite, 43
 - Spotlight, 33
 - SP Mode, 24
 - STANDBY Button, 23
 - Storage, 66
 - Supporting the Camera, 17
 - S-video, 56
 - System Diagram, 72
- T** Tally Lamps, 21
 - Tape Protection, 16
 - Telephoto, 25
 - Temperature, 64, 66
 - Time Code, 83
 - Tripod, 65
 - Troubleshooting, 69
 - TV, 56, 80
- U** Using the Camera Abroad, 67
 - Using the Menus, 18
- V** VCR, 56, 57
 - Videocassettes, 15
 - Video Heads, 67
 - Viewfinder, 10, 67
- W** Wide-angle, 25
 - Widescreen TV, 41
 - Wireless Controller, 20
 - White Balance, 49
- X** XL Lens, 8
- Z** Zebra Pattern, 47
 - Zooming, 25

U.S.A.

CANON® XL1 DIGITAL VIDEO CAMCORDER LIMITED WARRANTY

The limited warranty set forth below is given by Canon U.S.A., Inc. ("CUSA") with respect to each Canon XL1 Digital Video Camcorder ("DV Camcorder") purchased and used in the United States.

Each Canon DV Camcorder, when delivered to you in new condition in its original container, is warranted against defective material or workmanship as follows: for a period of one (1) year from the date of original purchase (three (3) months in the case of the video head part), defective parts or DV Camcorders returned to a CUSA factory service center ("CUSA Center") or an authorized DV Camcorder service facility ("Service Facility"), and proven to be defective upon inspection, will be repaired or exchanged for new or comparable rebuilt parts or DV Camcorders. The warranty period for repaired or replacement parts or DV Camcorders shall begin upon shipment of the same, but shall in no event exceed the original warranty period of the defective part or DV Camcorder.

Non-Canon brand peripheral equipment and software which may be distributed with Canon DV Camcorders are sold "AS IS", without warranty of any kind by CUSA, including any implied warranty regarding merchantability or fitness for a particular purpose. The sole warranty with respect to such non-Canon brand items is given by the manufacturer or producer thereof.

CUSA shall have no responsibility under this limited warranty for use of Canon DV Camcorders in conjunction with incompatible peripheral equipment and incompatible software.

In order to obtain warranty service, contact the authorized Canon retail dealer from whom you purchased the DV Camcorder or call the CANON INFORMATION CENTER AT 1-800-828-4040 (which is open from 9:00 a.m. to 5:00 p.m. (E.S.T.), Monday through Friday, excluding holidays). Have your unit serial number and your date of purchase available when you make the call to expedite service. In either case you will be directed to ship the DV Camcorder, postage prepaid, to the CUSA Center or Service Facility nearest to you. You must include a copy of the proof of purchase (bill of sale) and a complete explanation of the problem. DV Camcorders covered by this limited warranty will be repaired and returned to you without charge by the CUSA Center or the Service Facility. Repairs not under warranty will be at such cost as the CUSA Center or Service Facility may from time to time generally establish.

This limited warranty covers all defects encountered in normal use of the DV Camcorder, and does not apply in the following cases:

- (a) Loss of or damage to the DV Camcorder due to abuse, mishandling, improper packaging by you, alteration, accident, leaking batteries, exterior nicks, scratches or dents, electrical current fluctuations, failure to follow operating instructions, maintenance and environmental instructions prescribed in CUSA's instruction manual, or service performed by other than a CUSA Center or Service Facility.
- (b) Use of parts or supplies (other than those sold by CUSA) which cause damage to the DV Camcorder or cause abnormally frequent service calls or service problems.
- (c) If any DV Camcorder has had its serial number or dating altered or removed.

This limited warranty does not apply to accessories or consumables for the DV Camcorder, which are sold "AS IS", without warranty of any kind by CUSA.

NO IMPLIED WARRANTY, INCLUDING ANY IMPLIED WARRANTY OF MERCHANTABILITY OR FITNESS FOR A PARTICULAR PURPOSE, APPLIES TO THE DV CAMCORDER AFTER THE APPLICABLE PERIOD OF EXPRESS WARRANTY STATED ABOVE, AND NO OTHER EXPRESS WARRANTY OR GUARANTY, EXCEPT AS MENTIONED ABOVE, GIVEN BY ANY PERSON, FIRM OR CORPORATION WITH RESPECT TO THE DV CAMCORDER SHALL BIND CUSA. (SOME STATES DO NOT ALLOW LIMITATIONS ON HOW LONG AN IMPLIED WARRANTY LASTS, SO THE ABOVE LIMITATION MAY NOT APPLY TO YOU) CUSA SHALL NOT BE LIABLE FOR LOSS OF REVENUES OR PROFITS, EXPENSE FOR SUBSTITUTE EQUIPMENT OR SERVICE, STORAGE CHARGES, LOSS OF DATA, OR ANY OTHER SPECIAL, INCIDENTAL OR CONSEQUENTIAL DAMAGES CAUSED BY THE USE, MISUSE OR INABILITY TO USE THE DV CAMCORDER, REGARDLESS OF THE LEGAL THEORY ON WHICH THE CLAIM IS BASED, AND EVEN IF CUSA HAS BEEN ADVISED OF THE POSSIBILITY OF SUCH DAMAGES. NOR SHALL RECOVERY OF ANY KIND AGAINST CUSA BE GREATER IN AMOUNT THAN THE PURCHASE PRICE OF THE DV CAMCORDER SOLD BY CUSA AND CAUSING THE ALLEGED DAMAGE. WITHOUT LIMITING THE FOREGOING, YOU ASSUME ALL RISK AND LIABILITY FOR LOSS, DAMAGE OR INJURY TO YOU AND YOUR PROPERTY AND TO OTHERS AND THEIR PROPERTY ARISING OUT OF USE, MISUSE OR INABILITY TO USE THE DV CAMCORDER NOT CAUSED DIRECTLY BY THE NEGLIGENCE OF CUSA. (SOME STATES DO NOT ALLOW THE EXCLUSION OR LIMITATION OF INCIDENTAL OR CONSEQUENTIAL DAMAGES, SO THE ABOVE LIMITATION MAY NOT APPLY TO YOU.) THIS LIMITED WARRANTY SHALL NOT EXTEND TO ANYONE OTHER THAN THE ORIGINAL PURCHASER OF ANY DV CAMCORDER, OR THE PERSON FOR WHOM IT WAS PURCHASED AS A GIFT, AND STATES YOUR EXCLUSIVE REMEDY.

This limited warranty gives you specific legal rights, and you may also have other rights which vary from state to state.

Canon U.S.A., Inc.
One Canon Plaza
Lake Success, New York 11042

CANADA

CANON CONSUMER DIGITAL VIDEO EQUIPMENT LIMITED WARRANTY

The limited warranty set forth below is given by Canon Canada Inc. ("Canon Canada") with respect to Canon digital video equipment purchased in Canada. This limited warranty is only effective upon presentation of a bill of sale or other proof of purchase for this Canon digital video equipment to a Canon Service Facility when repairs are required.

Canon consumer video digital equipment is warranted under normal, non-commercial, personal use, against defective materials or workmanship as follows:

Parts: Defective parts will be exchanged for new parts or, at Canon Canada's option, comparable rebuilt parts for a period of one year from the date of original purchase, except Video Heads which will be exchanged for a period of 3 months from the date of purchase.

Labour: For a period of one year from the date of original purchase, labour will be provided free of charge by our Canon Service Facilities in Canada.

This limited warranty covers all defects except where:

- (a) The loss or damage to the product results from:
 - i) accident, natural disaster, mishandling, abuse, neglect, unauthorized product modification or failure to follow instructions contained in the instruction manual;
 - ii) the use of accessories, attachments, products, supplies, parts or devices with this Canon product that do not conform to Canon specifications or that cause abnormally frequent service problems;
 - iii) repairs or services performed by any party other than a Canon Service Facility;
 - iv) defective batteries or any exposure to water, sand or dirt;
 - v) shipping (claim must be presented to the shipper);
- (b) Any serial number on the video equipment is altered or removed.
- (c) The digital video equipment is used for commercial, professional or industrial purposes.

This limited warranty does not cover the cabinet (exterior finish) of the digital video equipment, video cassette tapes, head cleanings, nor does it apply to digital video equipment purchased outside Canada.

TO OBTAIN WARRANTY SERVICE

Ship your Canon digital video equipment in its original carton, box or equivalent, properly packed, fully insured with shipping charges prepaid, together with a copy of your bill of sale or other proof of purchase and a description of the problem to any of the Canon Service Facilities in Canada.

LIMITATIONS

Except as otherwise required by applicable legislation, this warranty is in lieu of all other warranties, conditions, guarantees or representations, express or implied, statutory or otherwise, relative to this Canon product, including implied warranties or conditions of merchantability or fitness for a particular purpose.

Canon Canada assumes no liability for special, consequential or incidental damages or loss that may arise, whether on account of negligence or otherwise, from the use, misuse or inability to use this Canon product (including loss of profit, revenue, video tapes or enjoyment) or from failure to conform to any express or implied warranties, conditions, guarantees or representations. Any recovery under this limited warranty shall not exceed the purchase price of the product. Canon Canada does not assume or authorize any other person to assume for Canon Canada any other liability with respect to this Canon product.

This warranty does not extend to any person other than the original purchaser of this Canon product or the person for whom it was purchased as a gift and states your exclusive remedy.

NOTICE TO CONSUMER

If you plan to take important videos or if the product has not been used for some time, please check all functions with the instruction book before using it.

E

**Additional
Information**



CANON INC.

30-2, Shimomaruko 3-chome, Ohta-ku, Tokyo 146-8501, Japan

U.S.A. ————— **CANON U.S.A., INC. NEW JERSEY OFFICE**
100 Jamesburg Road, Jamesburg, NJ 08831 USA

CANON U.S.A., INC. CHICAGO OFFICE
100 Park Blvd., Itasca, IL 60143 USA

CANON U.S.A., INC. LOS ANGELES OFFICE
15955 Alton Parkway, Irvine, CA 92718 USA

CANON U.S.A., INC. HONOLULU OFFICE
1020 Auahi Street, Bldg. #8, Honolulu, HI 96814 USA

- If you have any questions, call the Canon U.S.A. Information Center toll-free on 1-800-828-4040 (U.S.A. only).

CANADA ————— **CANON CANADA INC. NATIONAL HEADQUARTERS**
6390 Dixie Road, Mississauga, Ontario L5T 1P7

CANON CANADA INC. CALGARY
2828, 16th Street, N.E. Calgary, Alberta T2E 7K7

CANON CANADA INC. MONTREAL
5990 Côte de Liesse, Quebec H4T 1V7

- If you have any questions, please call toll-free in Canada 1-800-828-4040.
- Si vous avez des questions, veuillez téléphoner sans frais au Canada 1-800-828-4040.

MEXICO ————— **CANON MEXICANA, S. DE R.L. DE C.V.**
Periferico Sur No. 4124 Col. Ex-Rancho de Anzaldo C.P. 01900
México, D.F., México

CENTRO Y SURAMÉRICA — **CANON LATIN AMERICA, INC.**
6505 Blue Lagoon Drive Suite 325 Miami FL 33126 USA

ASIA ————— **CANON HONGKONG COMPANY LTD.**
9/F, The Hong Kong Club Building, 3A Chater Road, Central, Hong Kong