

SOUND DEVICES



552

**Five-Channel Portable Production Mixer
with Integrated Recorder
User Guide and Technical Information
firmware rev. 1.2**

Sound Devices, LLC
300 Wengel Drive • Reedsburg, WI • USA
+1 (608) 524-0625 • fax: +1 (608) 524-0655
Toll-Free: (800) 505-0625
www.sounddevices.com
support@sounddevices.com



Table of Contents

Quick Start Guide	3	Metering	28
Front Panel Descriptions	8	Meter Ballistics	
Rear Panel Descriptions	11	VU	
Left Panel Connectors and Controls	11	Peak	
Right Panel Connectors and Controls	12	Peak + Peak Hold	
Top and Bottom Panels	13	Peak + VU	
Voice Prompt	13	Peak Hold + VU	
Input Setup and Control	14	Zoom Metering	
Mic/Line Selection		Input Activity LED	
Phantom Power		Headphone Peak LED	
Gain - Trim and Fader Relationship		Headphone Monitoring	30
Input Trim		Headphone Gain	
Input Fader		Headphone Source Selection	
High-Pass Filter		Headphone Tones	
Pan Control		Record Start and Stop Tones	
Input Polarity		Playback Navigation Tones	
Stereo Linking		PFL (Channel Solo Monitor)	
Stereo Pair Linking		RTN A and B	
MS Pair Linking		Split Ear Return Monitoring	
Input Muting		Powering	32
Output Setup and Control	18	Internal Battery Powering	
Master Gain Control		External Powering	
Master Outputs		Voltage Metering	
XLR		Power Consumption	
TA3		Slate Mic/Tone Oscillator	33
Hirose 10-Pin		Slate Microphone	
Direct Outputs		Tone Oscillator	
Tape Outputs		Talk Back Mode	34
Mono Mic Output		Time of Day/Date Clock	36
AES Digital Outputs		Mixer Linking	36
Limiters	21	Linking 552 Mixers	
LIM and LINK		Linking to Other Mixers	
Digital Audio Recorder	22	Linking to a 302 or 442	
File Format		Linking to a MixPre	
WAV (Broadcast WAV)		Accessing the Setup Menu	38
MP3		User Settings	
Bit Depth		Factory Default Settings	
Bit Depth and Dynamic Range		Setup Menu Chart	39
Sampling Rate		Front Panel Button Shortcuts	41
Sampling Frequency and Audio Bandwidth		Connector Pin Assignments	43
Recording Media		Specifications	44
Folder Structure		Block Diagram - Inputs and Outputs	47
File Naming		Block Diagram - Monitoring	48
Automatic File Splitting		Block Diagram - AES	49
Recorder Controller		Accessories	50
REC LED		Wave Agent	51
Record Mode		CE Declaration of Conformity	52
Record Pause		Warranty and Technical Support	53
Time Code			
Time Code to Track			
External Time Code Auto Record			
Playback			

Welcome

Thank you for purchasing the 552 Mixer. It is the next evolutionary step in professional, portable audio mixers. With a core design based on the legendary 442, it contains countless improvements and added flexibility.

Developed with insight from the industry's top audio engineers, the 552 Field Mixer encompasses the audio performance, feature set, and mechanical construction demanded by those who rely on audio gear for their livelihood. The 552 contains five high-performance microphone preamplifiers, multiple outputs including AES outputs, comprehensive monitoring, and a high-quality built-in audio recorder. Its input and output flexibility, including pre- or post- fade direct outputs on each channel, make the 552 at home in small "run-and-gun" applications as well as large, multiple input productions.

The 552 incorporates a complete feature-set into a compact, functional design. 552 features are accessible from the three main surfaces. The Setup Menu can be accessed at anytime to make changes to various parameters. The highly efficient circuitry allows the mixer to be powered by either four internal AA batteries or external 10-18 VDC.

With a two-track recorder on-board, sound mixers can rest assured that audio is being recorded locally. The 552 records polyphonic Broadcast Wave or MP3 files to removable, Secure Digital (SD) or Secure Digital High Capacity (SDHC) cards.

The 552, like all Sound Devices professional audio products, is designed to withstand the physical and environmental extremes inherent to field production. Its compact construction strikes the perfect balance between performance, accessible controls, and durability.

Copyright Notice and Release

All rights reserved. No part of this publication may be reproduced, stored in a retrieval system, or transmitted in any form or by any means, electronic, mechanical, photocopying, recording, or otherwise, without the expressed written permission of SOUND DEVICES, LLC. SOUND DEVICES is not responsible for any use of this information.

SOUND DEVICES, LLC shall not be liable to the purchaser of this product or third parties for damages, losses, costs, or expenses incurred by purchaser or third parties as a result of: accident, misuse, or abuse of this product or unauthorized modifications, repairs, or alterations to this product, or failure to strictly comply with SOUND DEVICES, LLC's operating and installation instructions.

Microsoft Windows is a registered trademark of Microsoft Corporation. Macintosh is a registered trademark of Apple Computer. Other product and company names mentioned herein may be the trademarks of their respective owners.

The sound waves logo is a registered trademark of Sound Devices, LLC.

Quick Start Guide

This Quick Start Guide provides a brief overview for first use of the 552.

1) Connect power.

For internal powering from AA batteries, unscrew the battery cap (counter-clockwise), insert four AA batteries (not included) positive (+) side first into the battery tube. Thread the battery cap back on (clockwise). For external powering, connect a DC powering source (not included) to the DC connector on the Right Panel.

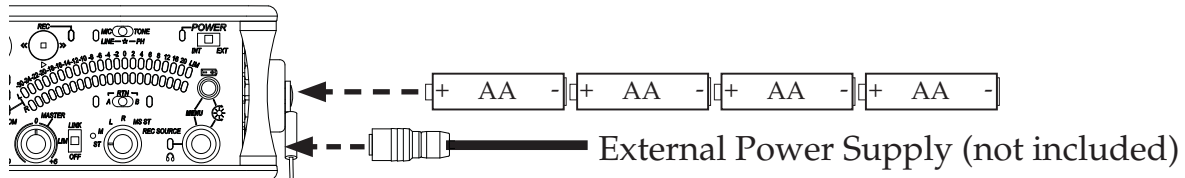

2) Connect analog microphone or line sources to the XLR inputs.

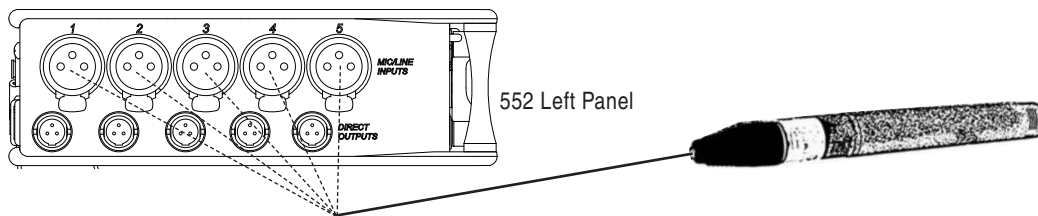

3) Connect headphones to either the 1/4-inch or the 3.5 mm headphone outputs.

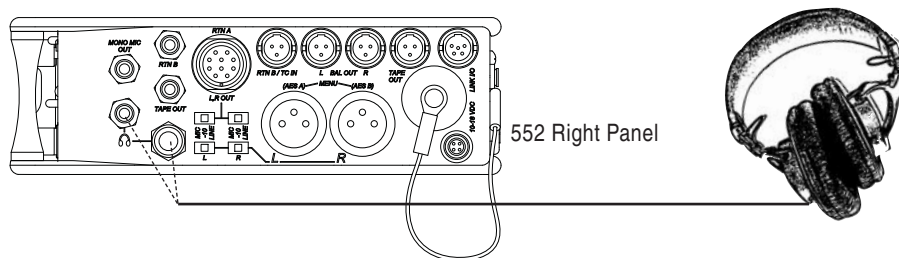

4) Power On the mixer.

Slide the power switch to the INT position to power the mixer from AA batteries. Slide the power switch to the EXT position to power the mixer from external DC.

Slide left for Internal AA Battery

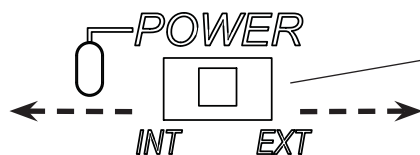

Slide right for External DC Power

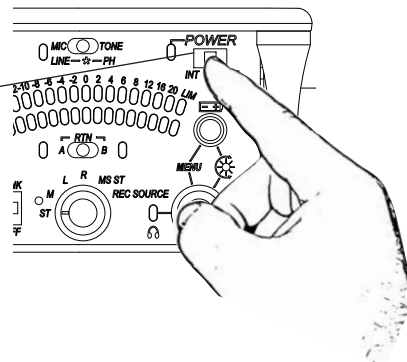

5) **Set Input Type – Mic or Line Level.**

To select an input to Mic or Line level, hold an input’s PFL switch, then slide the SLATE MIC/TONE switch to the left. The input’s LINE LED illuminates blue when set to line level and the LED is not illuminated when set to Mic level.

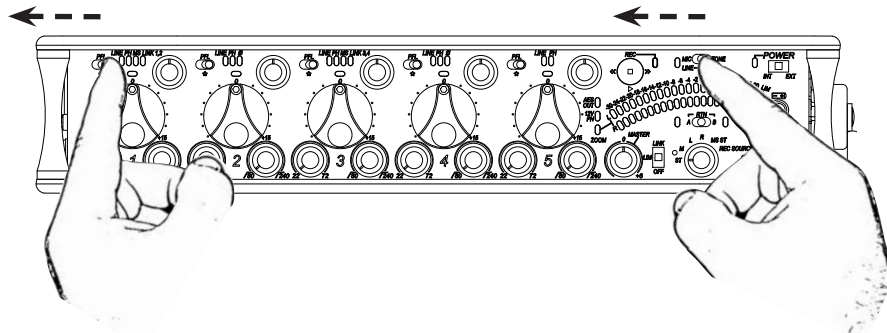

- 1) Hold the Input’s PFL.
- 2) Slide the SLATE MIC/TONE switch left.

6) **Apply Phantom Power to an input.**

The 552 supplies 48 V to inputs set to receive phantom power (PH). Phantom power can be set to 12 V in the Setup Menu. To apply phantom power, hold an input’s PFL switch, then slide the SLATE MIC/TONE switch to the right. The input’s PH LED illuminates blue when phantom power is applied.

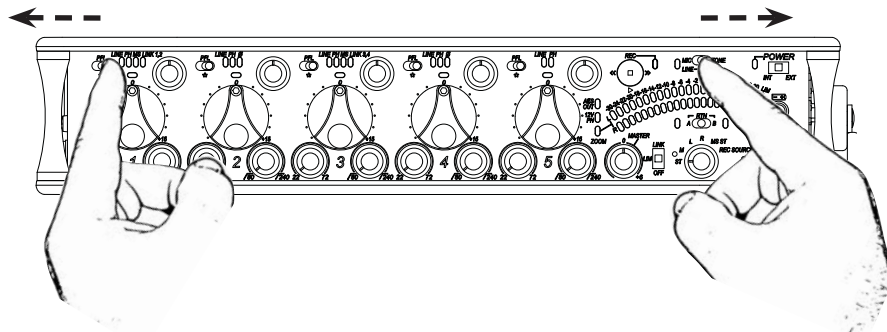

- 1) Hold the Input’s PFL.
- 2) Slide the SLATE MIC/TONE switch right.

7) **Select a headphone monitor mode using the Headphone Selector.**



MS Monitor Modes are useful to listen to left/right stereo when M and S signals are routed. When inputs are linked as an MS pair in the Setup Menu use the ST (Stereo program) monitor mode; this will already contain the decoded MS Stereo signal.

8) **Set the headphone level.**

Turn the Headphone Controller to set headphone levels. The currently selected headphone level is briefly indicated on the right output meter when the Headphone level control is turned.

9) **Set Input Faders in use to unity gain (0 dB or 12 o'clock).**

Faders not used should be set to off (full counter-clockwise position).

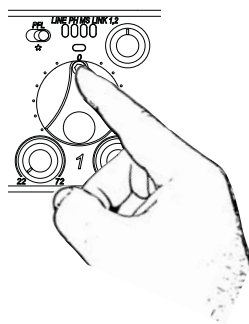

10) **Set Input Trim Levels.**

Push to release the recessed Trim (gain) Control. Turn the Trim Control clockwise to raise the level of the input. Once the gain has been set, push the Trim Control again to recess the control and remove it from the mixing surface. Use the Input Fader to make fine level adjustments.

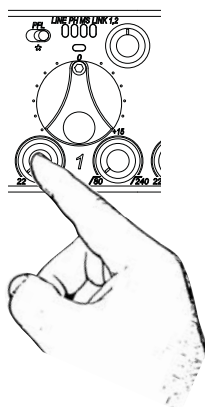

11) **Route each input to either Left or Right Outputs using the Input Pan Control.**

Push to release the recessed Pan Control. Turn counter-clockwise to send the input to the Left Output and turn clockwise to send it to the Right Output. Once the pan has been set, push the Pan Control again to recess the control and remove it from the mixing surface.

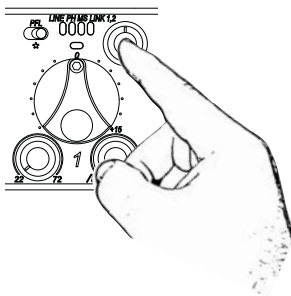

12) **Set High-Pass Filters and Limiters.**

Set the High-Pass Filter using the control adjacent to the Trim Control (full counter-clockwise position is off). Activate the Limiters using the switch adjacent to the Master Output Gain Control (Lim (dual Mono) Link (Stereo) applies to all inputs and outputs).

13) **Adjust LED Meter brightness.**

Press and hold the Battery Check button while turning the Headphone Controller.

14) **Check Internal and External power levels.**

Press the Battery Check  button to display the internal and external power levels on the Output Meter LEDs. The internal AA battery level is displayed on the left meter and external DC voltage level is displayed on the right meter.

15) **Connect the 552 analog outputs to the next device in the signal chain (audio recorder, wireless transmitter, or camera).**

Output levels are set (Line, -10, Mic) using the respective output's attenuation switch.

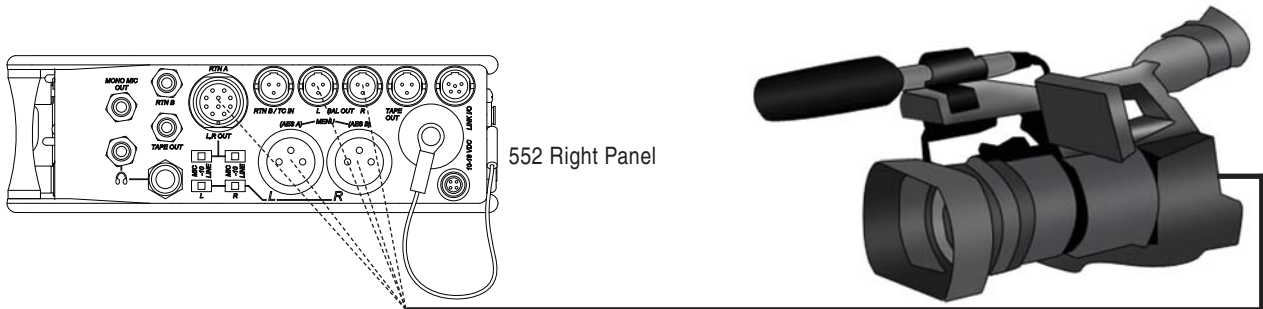

552 Right Panel

16) **Set the next device's input sensitivity to receive the supplied signal.**

17) **Activate the 552's Tone Generator.**

Slide the SLATE MIC/TONE switch to the TONE position. Tone latches on if the switch is held for two seconds; slide right again to turn off. A 1 kHz tone is generated and is sent out at 0 dB (level and frequency are menu-adjustable).

Slide left for Slate Mic

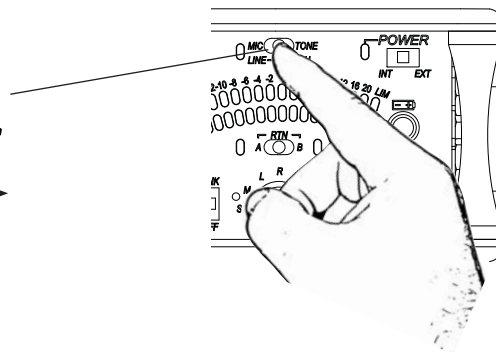
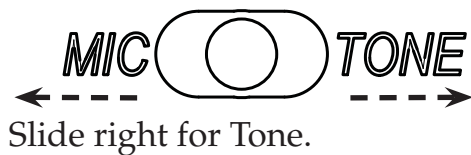

18) **Adjust the input gain on the next device accordingly.**

Voice Prompt

The 552 features a Synthetic Voice for Enhanced Navigation, or SVEN. SVEN provides spoken word feedback when Setup Menu features are adjusted. He is designed to simplify control and provide important information to the user. Additionally, SVEN provides status information about the digital audio recorder and time and date information. SVEN is routed only to the headphone outputs.

19) Setting the Time and Date.

Press and hold the Battery Check button for the mixer to announce in headphones the current time and date. If the setting spoken back in headphones is incorrect see Time of Day/Date Clock section of the 552 User Guide.

20) Insert an SD memory card into the back panel SD Slot.

Remove the protective rubber cover to access the SD memory card slot. Insert the SD card into the slot until it sits securely in the slot. The card should glide smoothly into the slot. Do not use excessive force when inserting the card and make certain that the electrical contacts are facing downwards. Push on the card to remove it.

21) Controlling the Integrated Digital Recorder.

The Recorder Controller is used to initiate the Record, Stop, Playback, Rewind, Fast Forward functions as well as to navigate through recorded files.

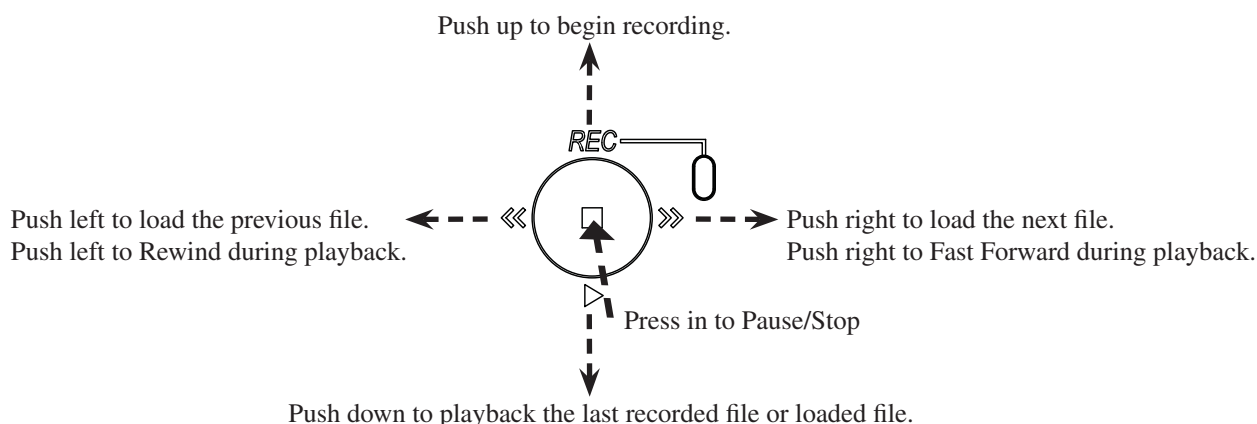

22) Making Changes in the Setup Menu.

The 552 has many features that are accessed through its Setup Menu. For details on entering and controlling the Setup Menu see Accessing the Setup Menu section in the 552 User Guide.

23) Power Down the Mixer.

Slide the power switch to the center position to power down. All settings are saved to EEPROM and will be saved and recalled upon next power on whether or not the unit is powered or has batteries.

Front Panel Descriptions

All 552 settings are accessed and controlled from the Front Panel. This allows the unit to be placed in a production bag while having complete control of the unit.

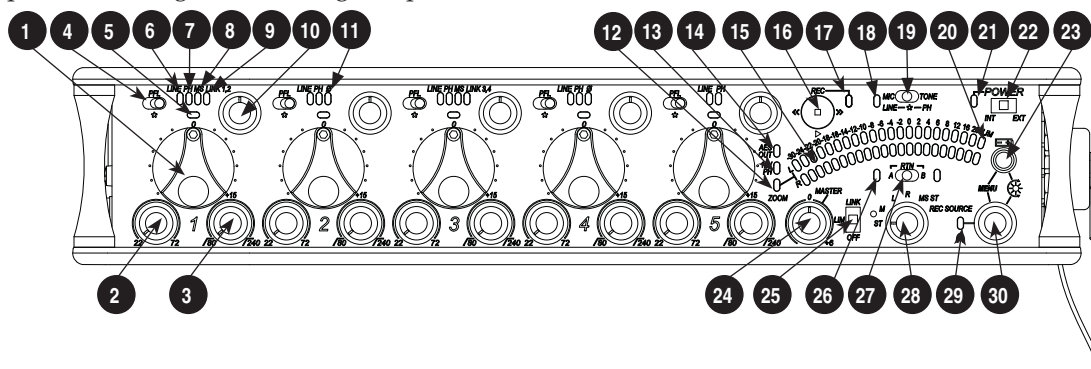

- 1) **Input Fader**
Primary control for adjusting the level of an input during operation. Ranges from Off to +15 dB. Nominal setting is in the middle (0 dB).
- 2) **Gain (Trim)**
Coarse input gain control. Sets the initial input sensitivity level so that the Input Fader can be used for fine gain adjustments. Range is from +22 dB to +72 dB. *See Input Setup and Control.*
- 3) **High-Pass Filter Control**
Adjusts corner (-3 dB) frequency of high-pass filter. Full counter-clockwise position (detented) deactivates the High-Pass Filter. Range is 80-240 Hz, 12 dB/oct to 6 dB/oct. *See Input Setup and Control.*
- 4) **PFL/Input Solo Switch**
Pre-Fade Listen. Sends the input's pre-fade signal to headphones for solo monitoring, troubleshooting, and gain setting. Does not affect Master Output signal. Slide the switch left to activate, and again to deactivate. For momentary action, hold the switch left for one second or longer. The Input Signal Activity LED flashes yellow when an input's PFL is latched on. The Input PFL Switch is also used to make changes to several input settings. *See Input Setup and Control.*
- 5) **Input Signal LED**
Indicates input signal activity. LEDs illuminate in various colors and intensities to show signal level and activity. Green = signal presence (pre-fader), yellow = limiter activity (pre- and post-fade) also flashes when solo is latched on, red = signal overload/clipping (pre- and post-fade) also solid when input is muted. *See Metering.*
- 6) **Mic/Line LED**
Illuminates blue to indicate an input is set to Line level. To toggle between Mic and Line settings, hold the input PFL then slide the Slate Mic/Tone Switch to the Slate position.
- 7) **PH/Phantom LED**
Illuminates blue to indicate an input's phantom power is on. To toggle phantom power on and off, hold the selected input's PFL switch then slide the Slate Mic/Tone switch to the Tone position. Phantom power voltage can be set to 12 or 48 V (48 V is Factory Default). Phantom voltage is set in the Setup Menu. The phantom power voltage is applied across all inputs with the PH LED illuminated.
- 8) **MS LED**
Inputs 1, 2 and 3, 4 can be linked as an MS pair. When a pair is linked, the MS and LINK LED illuminate blue. Stereo linking configurations are selected in the Setup Menu. *See Stereo Linking.*

- 9) **Link LED**
Illuminates blue when Inputs are linked as a stereo pair. Stereo linking configurations are selected in the Setup Menu. *See Stereo Linking.*
- 10) **Input Pan**
Controls the Left/Right balance of the input signal to the outputs.
- 11) **Input Polarity (Inputs 2 and 4 only)**
Illuminates blue when the Input's polarity is reversed. To toggle the state of the input polarity, hold the selected input's PFL then press the Battery Check button.
- 12) **Zoom LED**
Illuminates blue when the Output Meter is in Zoom Mode. Zoom Mode allows the user to view higher resolution in the 0 to +20 dBu range on the Output Meter. To toggle Zoom on and off, press in on the Headphone Controller. The Zoom Function is defeated in the Setup Menu Function Meter Ballistics. *See Metering.*
- 13) **Time Code LED**
Time Code is selected from the Setup Menu. When on, the LED flashes blue when Time Code is active but not being received. The LED Illuminates solid blue when the unit is receiving valid time code. Time Code is connected to the RTN B TA3 connector and is stamped to files generated by the 552's recorder. *See Time Code.*
- 14) **AES Out LED**
Illuminates blue when one or more of the AES outputs is active. *See Digital Outputs.*
- 15) **Output Meter**
Multi -segment LED output meter. Scale is normally -30 dBu to +20 dBu. In Zoom Mode, scale changes from 0 dBu to +20 dBu. To engage Zoom mode, press in on the Headphone Controller. *See Metering.*
- 16) **Recorder Controller**
Controls the Integrated Digital Recorder. Record Mode is enabled in the Setup Menu. When enabled, push up to Record, press in to Pause/Stop, push down to Play, push left to Rewind, push right to Fast Forward. *See Digital Audio Recorder.*
- 17) **Record LED**
Indicates the status of the recording media. The LED is off when the recorder is in standby mode. Flashes yellow when no SD card is inserted. Illuminates solid red while recording, flashes red when record is pending. Illuminates solid green while in playback mode. Flashes green while playback is paused. Illuminates solid yellow when media is busy. The LED is off when recorder is off.
- 18) **Slate/Tone LED**
Illuminates yellow when either the slate mic or tone is latched on.
- 19) **Slate Mic/Tone Switch**
Slide left to activate the Slate Microphone, slide again to deactivate. For momentary action hold for one second or longer. Slide Slate Mic/Tone switch right to activate the Tone Oscillator. Tone will latch if held for 2 seconds or longer, slide again to deactivate. This switch also functions as input type and phantom power select. *See Tone Oscillator/Slate Mic. See also Talk Back for additional features.*
- 20) **Limiter LED**
Each Output has its own Limiter LED. The LEDs illuminate yellow when the Output Limiter is active. *See Output Limiter.*
- 21) **Power LED**
When powering with internal AA batteries, the LED illuminates green when the 552 is on, turns yellow when low voltage point is reached, and flashes red when voltage reaches a critical level and batteries should be changed. When powering with external DC, the LED illuminates green when the 552 is on, flashes red when voltage drops below the set threshold. *See Powering.*

Front Panel Descriptions cont.

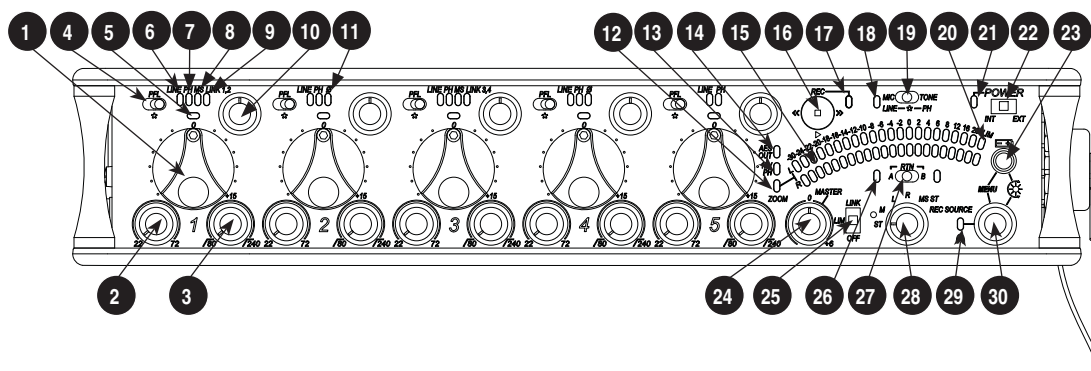

- 22) **Power Switch**
Three-position slide switch, selects between internal battery power or external DC sources, middle position is Off.
- 23) **Battery Check Button**
Press to display internal and external voltage levels on the Output Meter. Secondary function acts as shift key for various front panel features. Press and hold to announce card space available and current time and date.
- 24) **Master Output Level Control**
Controls the overall signal level of the Master Stereo Outputs. Adjustable from off to +6 dB. *See Outputs.*
- 25) **Limiter Switch**
Activates both Input and Output Limiters. When LIM is selected, the Output Limiters act independently on the Left and Right Outputs. When LINK is selected, the Output Limiters are linked and limiting is applied evenly across the Stereo Outputs. *See Limiter.*
- 26) **RTN A/B LED**
Indicates the activity for each return input. The LEDs illuminate in various colors and intensities to indicate the behavior of the return signals. Green = return signal presence, Red = return signal overload/clipping, Yellow = the monitor return is latched on. When time code is active, the TA3 input is used exclusively for time code. The 3.5 mm jack functions normally. *See Return.*
- 27) **RTN A/B Switch**
Two-position momentary switch. Slide left for RTN A headphone monitoring, slide right for RTN B headphone monitoring. Slide again to deactivate. For momentary action, hold for one second or longer. While holding the return switch, turn the Headphone Controller to adjust RTN A and RTN B levels. When time code is active, the TA3 input is used exclusively for time code. The 3.5 mm jack functions normally. *See Return and also RTN Loopback and Time Code.*
- 28) **Monitor Selection Switch**
Selects program sent to the headphone monitor. ST = stereo program, M = mono summed mix of Left and Right program, L = mono mix of Left program, R = mono mix of Right program, MS ST = decoded MS Stereo, REC Source = program routed to the recorder (AES A). *See Headphones.*
- 29) **Headphone Peak LED**
Illuminates red when the headphone monitor is approaching clip levels.
- 30) **Headphone Controller**
Controls headphone gain. Secondary functions include Setup Menu control, Zoom Mode, LED Brightness adjustment, and Return levels control.

Rear Panel Descriptions

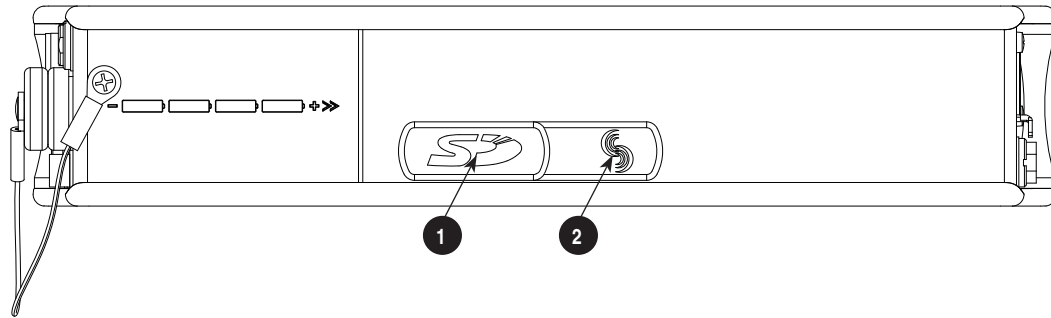

- 1) **SD Slot**
Protective rubber cover for SD (Secure Digital) memory card slot. Insert the SD/SDHC card into the slot until it sits securely in the slot. The card should glide smoothly into the slot. To remove the card, push to eject. MMC and SDXC cards are not supported.
- 1) **Factory Programming Port**
Mini USB port used for initial factory programming. This connection has no user function.

Left Panel Connectors and Controls

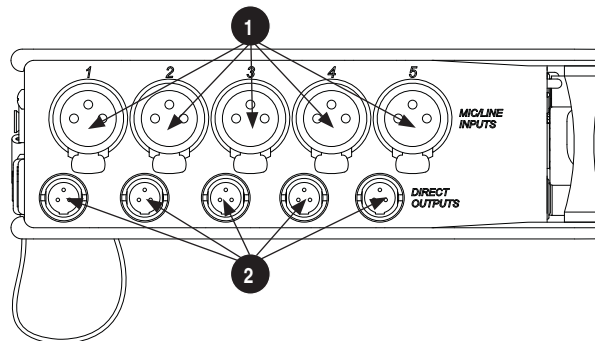

- 1) **Analog Inputs Channels 1-5**
Transformer-balanced analog microphone- or line-level inputs 1-5 on XLR connectors. Pin 1 = Ground; pin 2 = Hot (+); pin 3 = Cold (-). For unbalanced inputs, tie pin 1 and pin 3 together = ground, pin 2 = positive. Make certain phantom power is off when using unbalanced inputs. *See Input Setup and Control.*
- 2) **Analog Direct Outputs**
Balanced direct outputs on TA3 connectors. Slate Mic and Tone signals appear at the direct outputs. Direct output signal is pre- or post-fader and level is selected in the Setup Menu between Line, -10, and Mic levels. Pin 1 = Ground; pin 2 = Hot (+); pin 3 = Cold (-) float pin 3 to unbalance.

Right Panel Connectors and Controls

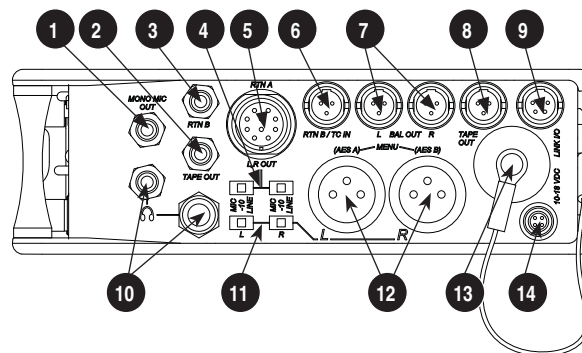

- 1) **Mono Mic Out**
Unbalanced mono mic-level output on 3.5 mm female connector, designed to connect to wireless IFB transmitters or transcription recorders. Tip = Hot (+), Sleeve = Ground.
- 2) **Tape Out**
Unbalanced stereo output on 3.5 mm female connector. Sleeve = Ground, Tip = Left, Ring = Right.
- 3) **RTN B In**
Unbalanced stereo 3.5 mm female connector for Return B audio input. Sleeve = Ground, Tip = Left, Ring = Right. *See RTN B and RTN Loopback Mode.*
- 4) **10-Pin Output Level Switch**
Selects the Hirose 10-Pin Output level between Line, -10, or Mic levels.
- 5) **10-Pin Master Outputs and Return A**
10-pin connector includes second master output (transformer-isolated from the XLR outputs) and unbalanced stereo Return A. Can be set to send out AES digital signals. *See AES Digit Outputs.*
- 6) **RTN B / TC Input**
Unbalanced stereo input for Return B audio and Time Code input on TA3 connector. RTN B wiring pin 1 = Ground, pin 2 = Left, pin 3 = Right. Time Code wiring pin 1 and 3 = ground, pin 2 = Hot (+). *See Time Code.*
- 7) **TA3 Master Outputs**
Line, -10, or Mic level selected in the Setup Menu. Pin 1 = Ground, pin 2 = Hot (+), pin 3 = Cold (-) float pin 3 to unbalance.
- 8) **Tape Output**
Unbalanced tape-level stereo output on TA3 connector. Pin 1 = Ground, pin 2 = Left, pin 3 = Right.
- 9) **Link I/O**
Used to link additional Sound Devices 552, 302, 442, or MixPre mixers. *See Mixer Linking.*
- 10) **Headphone Outputs**
1/4-inch and 3.5 mm stereo connectors, drive headphones from 8-2000 ohm impedances. 3.5 mm connection can be set in the Setup Menu as an independent boom operator send. *See Talk Back Mode.*
- 11) **XLR Output Level**
Sets the nominal output level for the Left and Right XLR Master Output to Line, -10, or Mic levels.
- 12) **XLR Master Outputs**
Transformer-balanced analog outputs on standard 3-pin XLR connectors. Pin 1 = Ground; pin 2 = Hot (+); pin 3 = Cold (-). Unbalance by tying pin 3 to pin 1. Can be set to send AES3 digital signals in the Setup Menu. *See AES Digit Outputs.*
- 13) **Battery Compartment**
Holds four AA batteries required for internal powering. Accepts Lithium, Alkaline, and NiMH rechargeable cells.
- 14) **DC Input**
Accepts DC voltages from 10–18 V for mixer powering. Pin 1 = Negative (-), pin 4 = Positive (+). Ext DC is completely isolated (floating) from the rest of the circuitry.

Top and Bottom Panels

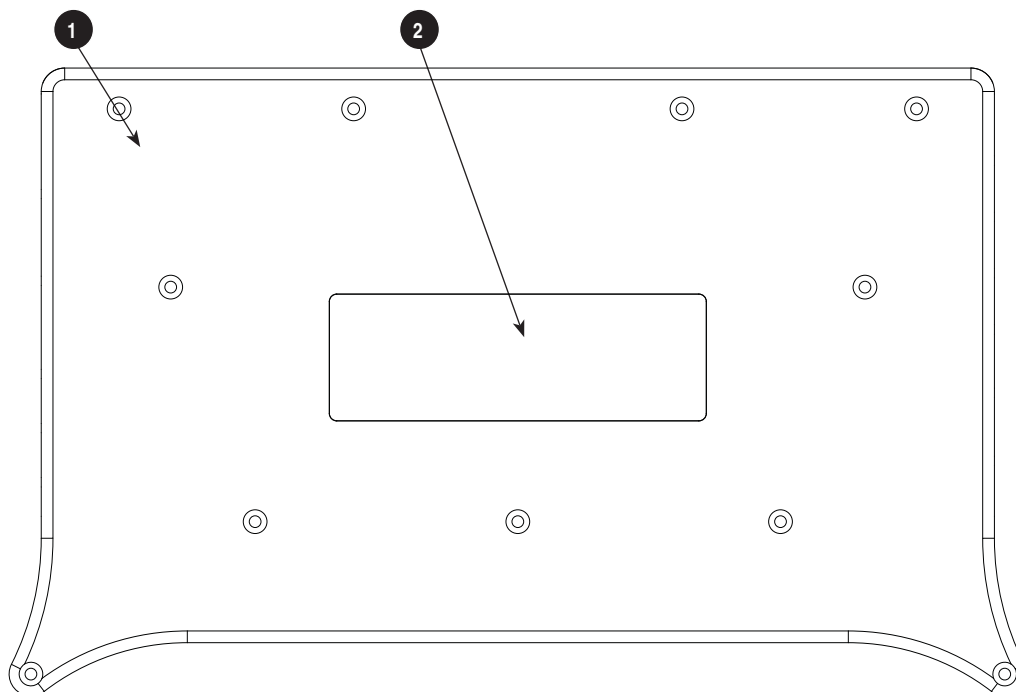

1) Top and Bottom Panels

Made of molded carbon fiber, this highly specialized composite has nearly identical strength-to-weight properties as die-cast magnesium. Additionally, the material also has the natural RF shielding abilities similar to aluminum.

2) Product Badge

The product badge on the bottom panel can be covered with a customized identity tag. The label place holder on the bottom panel conforms to the 4" x 1.33" Avery label #5162 standard. Third party software for Avery label #5162 templates are available online.

Voice Prompt

The 552 features a Synthetic Voice for Enhanced Navigation, or SVEN. SVEN provides spoken word information in headphones when Setup Menu features are adjusted. SVEN is designed to simplify control and provide important information to the user. Additionally, SVEN provides status information about the digital audio recorder and time and date information. SVEN is sent only to the headphone outputs. If Talk Back Mode is selected, SVEN only appears on the 1/4" headphone output. *See Talk Back for details.*

The 3.5 mm headphone output does not receive SVEN announcements when Talk Back Mode is active.

The following information is reported by the SVEN.

Function	Description
Card Space Available	Press and hold the Battery Check button to announce the remaining card space available. SVEN automatically announces remaining record time at 15, 10, 5, and 2 minutes remaining.
Time and Date	Continue to hold the Battery Check button after Card Space Available announcement to hear the current time and date.
Time Date Set	Hold Input 5's PFL then press the Battery Check button and the Headphone Controller to enter Time Date Set. The unit of time and each value is announced when turning Headphone Controller.
Setup Menu Navigation	While in the Setup Menu, the current Function or Option is announced with each turn of the Headphone Controller.
Playback Navigation	Announces the file number of the selected file. If navigating through folders, SVEN announces the selected daily folder.
Media Busy Indication	"Media Busy" is announced if the SD card is not available to respond to a command.
Full SD Card	"Full SD Card" is announced when there is no space remaining on the SD card and a record command has been given.
Record Mode Off	"Record Mode Off" is announced if the recorder receives a command and the recorder is disabled in the Setup Menu.
Next File	Press the Recorder Controller in stand-by mode to announce the file number of the next take to be recorded.

Input Setup and Control

The 552's inputs consist of five, full-featured preamplifiers. Each input has a wide gain range to accommodate nearly all signal types of microphone and line. The 552 easily accepts signals from low-sensitivity ribbon and dynamic microphones, medium-level wireless and condenser mic outputs, and "hot" line-level signals.

The XLR inputs of the 552 are transformer-balanced. The isolation characteristics of transformers are superior to other balancing techniques and are ideal for the hostile and uncontrolled environments of field production. Transformers provide galvanic isolation from the driving source, meaning there is no direct electrical connection. Signals are "transformed" magnetically. The input transformers in the 552 use premium magnetic core material to achieve high signal-handling-capability (especially at low frequencies) while keeping distortion to a minimum. Because of their inherently-high common mode impedance, transformers are unrivaled by any other type of input for common-mode noise rejection.

The inputs of the 552 can be used as balanced or unbalanced. To unbalance, tie pin-3 to pin-1 of the XLR connector. There is no change in gain between unbalanced and balanced connections into the 552.

Mic/Line Selection

LINE PH MS LINK 1,2

Two input modes are available, Mic and Line. When Line is selected the LINE LED is illuminated. Taking into account all gain stages, the 552 has 93 dB of available gain from Mic input to Line output. When inputs are set to the LINE position, the input sensitivity is reduced by 40 dB.

The selected channel is set to receive a line level input when the Line LED adjacent to the input's PFL is illuminated. To toggle between Mic/Line levels, hold the respective input's PFL and then slide the Slate Mic/Line switch to the Slate position.

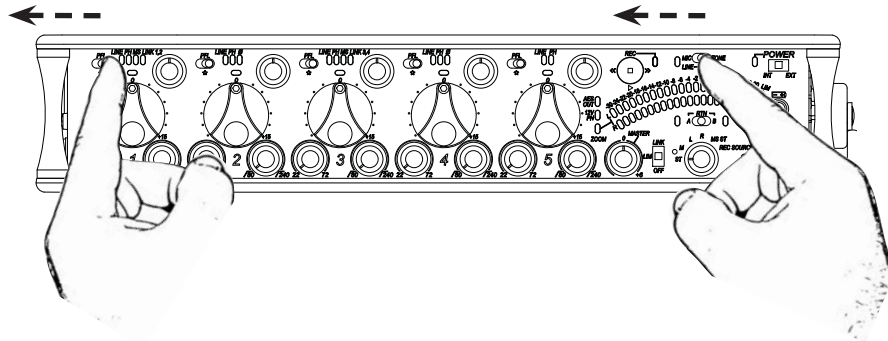

- 1) Hold the Input's PFL.
- 2) Slide the SLATE MIC/TONE switch left.

Phantom Power

LINE PH MS LINK 1,2
 0000

Phantom powering is a fixed DC voltage of either 12 or 48 Volts. This voltage is resistively applied to pin 2 and pin 3 of an input's XLR connector, relative to pin 1. In this configuration, there is no voltage difference between signal pins 2 and pin 3.

The phantom voltage is selectable between 12 and 48 Volts in the Setup Menu. The selected voltage level applies to all inputs with phantom power enabled. Phantom power voltage is 48V at factory default. *See Setup Menu.*

Phantom power can be activated individually for each input. To enable or disable phantom power, press and hold the respective input's PFL switch then momentarily slide the Slate Mic/Tone switch to the Tone position. The respective input's PH LED illuminates when phantom is enabled.

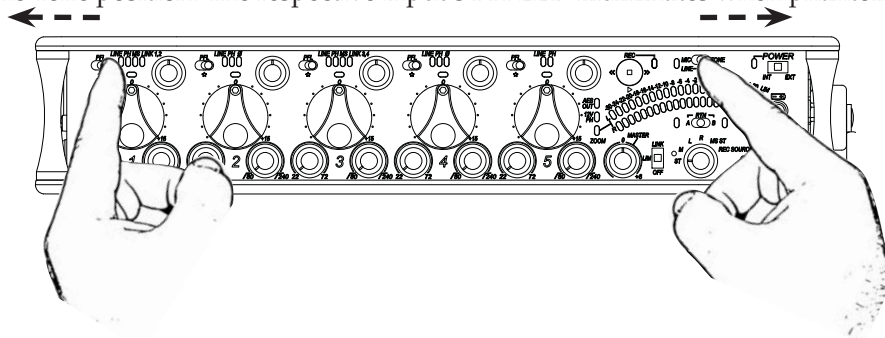

- 1) Hold the Input's PFL.
- 2) Slide the SLATE MIC/TONE switch right.

Phantom power is only applied to inputs set for Mic level at factory default. Phantom Power can be applied to inputs set to Line- and Mic-Level in the Setup Menu. This is useful when using microphones in high SPL environments.

Make certain to disable phantom power with Line-level output devices that are susceptible to damage from DC.

The 552 can provide up to 10 mA to each input at 48 V, sufficient for the most power-hungry condenser microphones. Many phantom powered microphones do not require 48 V and can be properly powered with 12 V. When acceptable, use 12 V phantom to extend the 552's battery life.

If Phantom Power is not required, for instance with dynamic microphones, it is best practice to disable it. Phantom power can capacitively couple noise into the mic inputs with poor mic cables. When

disabled, no voltage is applied to the microphone input. Do not apply power to ribbon microphones, improperly wired cables can permanently damage the microphone.

Gain - Trim and Fader Relationship

The gain of an input is adjusted by two controls, Input Trim and Input Fader. This two-stage architecture is identical to the topology of mixing consoles and provides a great deal of flexibility. Input Trim is often thought of as a coarse gain control and the Input Fader as the fine gain control.

Input Trim



The 552's input sensitivity is set with the pop-up knob Trim control. With the Input Fader set to unity gain (0 dB or 12 o'clock), make the appropriate adjustments using the Trim control. Once the coarse gain is set to the desired level, recess the Trim control to hide it from the 552's mixing surface. Trim level is adjustable from 22 to 72 dB of gain.

Input Fader

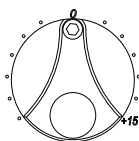

The Input Fader is the primary control used during mixing operation. Use the Input Fader to make fine gain adjustments during operation. The fader can be attenuated from off (full counter-clockwise position) to +15 dB above the set Trim level (full clockwise position). To optimize gain structure for the best noise performance operate input faders at or near the 0 dB (unity gain) position.

High-Pass Filter



Each input channel has an adjustable high-pass filter controlled by the High-Pass Filter pop-up knob. High-pass (or low-cut/low roll-off) filters are useful for removing excess low frequency energy from audio signals. Wind noise is a common unwanted low frequency signal that can be reduced with the use of a high-pass filter. For most audio applications engaging the high-pass filter is beneficial, because audio information below 100 Hz is rarely used, especially for speech reproduction.

The 552's high-pass filter circuit features an adjustable corner (-3 dB) frequency over a range from 80 to 240 Hz. Below 80 Hz, the filter's slope is 12 dB/octave. At higher corner frequency settings, the slope is 6 dB/octave. *See Specifications.* The purpose for this compound slope is to give additional roll-off at the 80 Hz setting to reduce wind noise and low frequency rumble. The higher settings can be used to counteract the proximity effect of directional microphones where a more gentle slope is desired.

When engaged or disengaged, the high-pass filter gradually fades into the selected state. This prevents sudden obvious pops in the audio.

The 552's high-pass filter circuit is unique because of its placement before any electronic amplification. Most mixer's high-pass filter circuits are placed after the microphone preamplifier, such that all of the low-frequency signals get amplified. By virtue of the 552's circuit cutting the low-frequency signals before amplification, higher headroom is achieved in the presence of signals with significant low-frequency energy.

When possible, attempt to equalize at the sound source with microphone selection, placement, windscreens, and onboard microphone filtering. Many microphones have on-board high pass filters. Use the high-pass filters on the 552 in conjunction with the microphone's filter to increase the filter's slope.

The filter can be removed from the circuit completely by moving the high-pass filter control to the full counter-clockwise (detented) position. The high-pass filter potentiometer can be adjusted easily and then recessed to hide it from the mixing surface.

Pan Control

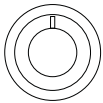

The pop-up knob control routes inputs to the left and right output buses. For most applications, a channel will be panned either hard-left, hard-right, or center. The pan pot has a detent in the center position. After setting the pan, the pan control can be recessed to hide it from the mixing surface during normal operation.

Input Polarity



The polarity (sometimes referred to as a phase inversion) of inputs 2 and 4 can be reversed. Polarity reversal is used to compensate for incorrectly wired balanced cables, to prevent signal cancellation when a source is dual-miked from opposite directions, or to reverse left/right with MS microphones. To toggle between normal and reverse polarity, activate the respective input's PFL then press the Battery Check Button. When the front panel Input Polarity LED is lit, the polarity is reversed on that channel.

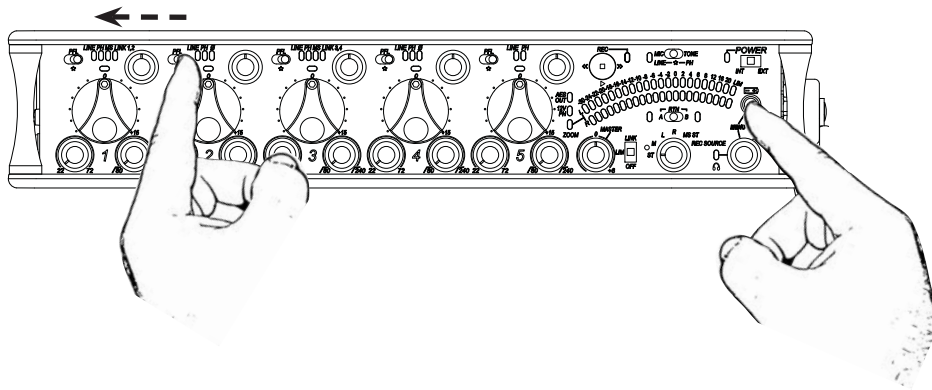

- 1) Hold the Input's PFL.
- 2) Press the Battery Check Button.

Stereo Linking

The Stereo Link feature allows two pairs of 552 inputs to be linked as stereo pairs. These are inputs 1,2 and inputs 3,4. In the Setup Menu inputs can either be linked as either a Stereo Pair or an MS Stereo Pair. Input Linking is indicated by the odd channel's (1 and 3) LINK LED. When an input pair is linked as an MS pair, both the Link and MS LEDs will be lit.

Stereo Pair Linking

LINE PH MS LINK 1,2
 0000

When Stereo Linking, input channels 1 and 2 and/or channels 3 and 4 act as a single stereo pair, controlled by the odd channel's Fader. The odd channel's Pan control acts as the balance control between left and right. The even channel's Fader and Pan controls are not active when inputs are linked. The Trim control and High-Pass Filters continue to act independently of each other. When linked, the channel's Input Limiters are also linked. When inputs are linked as a stereo pair the odd input's Link LED is illuminated.

MS Pair Linking

LINE PH MS LINK 1,2
 0000

When Linking inputs as an MS pair, channels 1 and 2 and/or channels 3 and 4 are linked as an MS pair. The odd input (1 and 3) is the Mid signal and the even input (2 and 4) is the Side signal. The odd channel's Pan Control functions as a left/right balance control for the matrixed MS signal. The even channel's Fader and Pan controls are disabled. Each channel's Trim control and high-pass filter continue to act independently of each other. Use channels 1 and 2's Trim controls to vary the Mid and Side levels respectively. When linked, the Input Limiters are also linked. When inputs are linked as an MS pair the odd input's Link and MS LEDs will illuminate blue.

Input Muting

Any input can be removed from the mix so that its signal is not sent to the master left and right outputs. An input that is removed from the mix in this way is still present in the direct output and the isolated input selections for AES A source. *See AES Digital Outputs for details.*

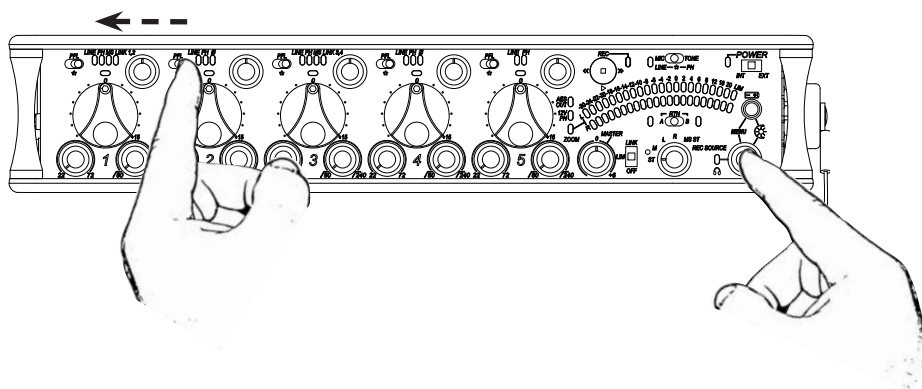

1) Press in on the headphone controller

2) Press the input's PFL.

Output Setup and Control

The 552 has stereo output bus that feeds multiple outputs. Additionally, each 552 input has its own direct output. This output flexibility is essential for complex, multi-camera productions.

Master Gain Control

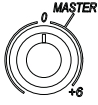

The Master Gain Control adjusts the overall output level of the left and right outputs. The gain range of the Master Gain Control is from Off to +6 dB of gain. For most applications the Master control should be set at the unity gain (0) position. The master gain is on a pop-up knob so it can be set and hidden from the main surface. It is best practice to hide the Master Gain Control so that inadvertent adjustments are avoided.

Master Outputs

The master outputs consist of three sets of connectors XLR, TA3, and Hirose 10-pin. The XLR and 10-pin outputs are transformer-balanced, each driven from their own transformer windings for excellent isolation. Each output can be independently set to Line (+4 dBu nominal), -10, or Mic level (40 dB of attenuation versus Line). The master outputs are capable of driving long cable runs.

XLR

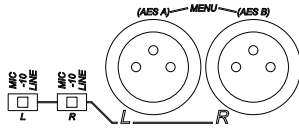

The XLR outputs are generally used as analog outputs but can be selected for AES3. At Factory Default, the XLR Outputs are analog. Each XLR connector is configured in the Setup Menu to output an AES3 digital signal. [See AES Digital Outputs for details.](#) When set as analog, the XLR labeled L will output the Left program, XLR labeled R will output the Right program. Each output can be set to output at Line, -10, or Mic levels using the adjacent level switches.

TA3

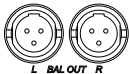

The TA3 master outputs, located above the XLR Master Outputs, are an additional set of master outputs. These outputs are active-balanced and can be used as either balanced or unbalanced. The output level is set between Line, -10, and Mic levels from the Setup Menu. At Factory default, the output level of the TA3 Master Outputs is Line Level.

Hirose 10-Pin

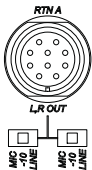

The 10-Pin outputs are used as either analog or digital outputs. At Factory Default, the 10-Pin Outputs are analog. Each output is configured in the Setup Menu to output an AES digital signal. [See AES Digital Outputs for details.](#)

The Hirose 10-Pin connector contains balanced analog Left and Right outputs. The output level is selectable between Mic, -10, and Line levels using the level switches located directly below the con-

connector. The Hirose 10-Pin also includes an unbalanced stereo return (RTN A) input for headphone monitoring. The Sound Devices XL-10 Breakout Cable is an available accessory that provides easy access to the balanced outputs and stereo RTN A connection of the 10-pin Hirose connector. *See RTN and Connector Pin Assignments for details about the Hirose Multi-Pin connector.*

Direct Outputs



Each input channel has its own balanced TA3 Direct Output connection. These outputs are used to send the isolated channel's audio to another destination. The Direct Output signal is menu-selectable as either pre- or post-fader. When activated, the Slate Microphone and Tone Oscillator signals are also sent to the Direct Outputs. The nominal output level is selectable in the Setup Menu as Mic, -10, or Line level. *See Setup Menu.*

Tape Outputs

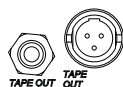

Tape Outputs are typically used to interface with consumer devices such as MiniDisc and compact transcription recorders. The 552 includes two unbalanced tape level outputs, a TA3 connector and a 3.5 mm jack. These two connectors are resistively in parallel and are isolated from the balanced outputs.

Tape Outputs, by default, send the Left and Right stereo program. Using the RTN Loopback function, the Tape outputs can be used to send the incoming RTN A or RTN B signals directly to receiving devices. *See RTN Loopback for more details.*

Mono Mic Output



The Mono Mic Output is a summed mix of the left and right output channels. The 3.5 mm female connector outputs a mono, mic-level signal intended for connection with portable transcription recorders and wireless IFB transmitters.

Using the RTN Loopback function, the Mono Mic output can be used to send the incoming RTN A or RTN B signals directly to receiving devices. *See RTN Loopback for more details.*

AES Digital Outputs

Each of the XLR or 10-pin Hirose outputs can be configured in the Setup Menu to output AES3 digital signals. The front panel AES Out LED is lit when one or both of the XLR or the 10-Pin outputs are selected as digital outputs. The Left XLR or 10-pin output contains the two-channel AES A pair, the Right XLR or 10-pin output contains the two-channel AES B pair. The selected output connector's Level Switch should be set to Line when using it as a Digital Output. In the Setup Menu, the following routings can be sent to each one of the AES pairs. Program before the comma appears on the left-side of the AES Output and program after the comma appears on the right.

- Left Program, Right Program
- Channel 1, Channel 2 Pre-Fade
- Channel 1, Channel 2 Post-Fade
- Channel 3, Channel 4 Pre-Fade
- Channel 3, Channel 4 Post-Fade
- Channel 5 Pre-Fade, Left Program
- Channel 1 Pre-Fade, Left Program
- Ch 1 Pre-Fade, Left Right Program (AES A Only)
- Ch 5 Pre-Fade, Left Right Program (AES B Only)

To route the desired program to AES A follow the steps below.

1. Enter the Setup Menu. Press and hold the Battery Check button then press the Headphone Controller.
2. Navigate to the Setup Menu Function AES A Source (-10 LED on the Left Meter). Turn the Headphone Controller to move through Setup Menu Functions. SVEN announces each function as you step through the menu.
3. Enter the Setup Menu Function AES A Source (-10). Press the Headphone Controller to select a function.
4. Navigate among the available routing options. SVEN announces each available routing as you step through the available options.
5. Select the routing. Press the Headphone Controller to select an option. This will exit the selected Setup Menu Function.
6. Exit the Setup Menu. Press any key other than the Headphone Controller to exit the Setup Menu.

To switch the XLR or 10-pin Outputs from analog to digital follow the steps below.

1. Enter the Setup Menu. Press and hold the Battery Check button then press the Headphone Controller.
2. Navigate to the Setup Menu Function Digital Output (-12 LED on the Left Meter). Turn the Headphone Controller to move through Setup Menu Functions. SVEN announces each function as you step through the menu.
3. Enter the Setup Menu Function Digital Output (-12). Press the Headphone Controller to select a function.
4. Navigate among the available options. SVEN announces each setting as you step through the menu.
5. Select the best option for your particular setup. Press the Headphone Controller to select an option. This will exit the select Setup Menu Function.
6. Exit the Setup Menu. Press any key other than the Headphone Controller to exit the Setup Menu.
7. Set the selected output's Output Level Switch to Line.

Limiters



When the 552 Limiters are engaged, it is nearly impossible to clip (overload) the 552 mixer. Activate the 552 limiters by setting the front-panel “LIM” switch to either LINK or ON. This enables both the input and output limiters and determines the behavior of the output limiter. Sound Devices recommends that the limiters be active at all times.

The Input Limiters act solely as “safety” limiters. In normal operation, with a properly set gain structure, the threshold of the Input Limiter will not be reached. In the event of extremely high input signal levels, such as in high SPL environments, an Input Limiter will activate to prevent the input signal from clipping. Without Input Limiters, high signal conditions can overload a channel and cause distortion.

The Limiters do not alter signals below the threshold. When Inputs are linked as a stereo pair, the Input Limiters are also linked and perform the same gain reduction equally across both inputs.

The Input limiter is active when the respective input's Input Activity LED illuminates yellow. If the Activity LED illuminates yellow substantially, reduce the amount of gain applied to the channel by turning down the Trim control. *See [Input Activity LED for additional information](#).*

The Output Limiters prevent the output signal from exceeding the user-set limiter threshold. In the Setup Menu the Output Limiter Threshold can be set in 1 dB increments from +4 dBu to +20 dBu. *See*

Setup Menu At Factory Default, the mixer is set to limit the output signal peak levels to +20 dBu. This assures that the output of the 552 will not overload inputs that accept full line-level signals.

The orange LIM LEDs, located at the end of the meter scale, illuminate in various intensities to represent output limiting.



LIM and LINK



The Output Limiters can either be linked as a stereo pair (LINK) or can work as two independent limiters (LIM). When linked, the limiters will apply the same gain reduction equally to both the Left and Right outputs. The LINK position is recommended when recording stereo program, so that level changes are identical for both channels. The LIM position is recommended when using the 552 Outputs as two separate buses.

Digital Audio Recorder

The 552 incorporates a high-quality, two-track digital audio recorder. The 552 records uncompressed polyphonic Broadcast Wave (.WAV file extension) or compressed MP3 (.MP3 file extension) files to a removable SD/SDHC card (not included). The audio source assigned to AES A is the source of the recorded audio. The AES A source is selectable in the Setup Menu. *See Digital Outputs for step-by-step AES A source routing instructions.*

Recording settings such as file format, bit depth, and sampling rate are set in the Setup Menu. All record functions are controlled using the Recorder Controller. From the factory, the recorder is set to record 24-Bit WAV files at 48 kHz sampling rate.

To make changes to the recording settings follow the steps below.

1. Enter the Setup Menu. Press and hold the Battery Check button, then press the Headphone Controller.
2. Navigate to the Setup Menu Function Record Mode (-20 LED on the Left Meter). Turn the Headphone Controller to step through the Setup Menu Functions. SVEN announces each Function as you step through the menu.
3. Enter the Setup Menu Function Record Mode (-20). Press the Headphone Controller to select a Function.
4. Move among the available record options. SVEN announces each setting as you step through the available options.
5. Select the option best suited for the application. Press the Headphone Controller to select an option and exit Setup Menu Function.
6. Navigate to the Setup Menu Function Sample Rate (-18 LED on the Left Meter).
7. Press the Headphone Controller to enter the Setup Menu Function.
8. Select a sampling rate best suited for the particular application.
9. Press the Headphone Controller to save the option and exit the Sample Rate Function.
10. Exit the Setup Menu. Press any key other than the Headphone Controller to exit the Setup Menu.

Press and hold the Battery Check button to have SVEN announce the remaining card space available in headphones. SVEN automatically announces the remaining time when 15, 10, 5, and 2 minutes are remaining on the SD card.

File Format

WAV (Broadcast WAV)

The 552 records two-channel, polyphonic AES-31 Broadcast Wave formatted audio files. These files place additional information in the file header, called the Broadcast Audio Extension data chunk, and in the iXML chunk. Audio editing software that does not recognize this additional information will ignore it and read the file as a standard WAV file. Values recorded in the BEXT and iXML are:

- time code stamp *See Time Code*
- time code frame rate
- time code user bits
- original date and time
- bit depth
- sampling rate
- track names
- take number
- file name
- machine serial number
- software version

MP3

MPEG-1 Layer III is a lossy compression algorithm, often used for music and transcription recording purposes. The 552 records two-channel MP3 audio files with the following data rates.

- 64 kb/s
- 128 kb/s
- 192 kb/s
- 320 kb/s

Bit Depth

When recording WAV files, the 552 records either 16 or 24 bit files. 24-bit recording provides greater dynamic range and additional headroom for signal peaks. Sound Devices recommends 24-bit recording for all critical production.

Bit Depth and Dynamic Range

Bit depth defines the digital “word length” used to represent a given sample. Bit depth correlates to the maximum dynamic range that is represented by the digital signal. Larger bit depths accommodate more dynamic range. A quick estimate of the maximum dynamic range capable of being represented by a given word length is dynamic range \approx no. of bits \times 6 dB. Bit depth is an exponential measure (exponent of 2), so as bit depth increases, the amount of data it represents increases exponentially. The majority of field recording is done with 16-bit audio, therefore each sample is represented by a digital word of 2^{16} (65,536) possible values. 24-bit audio has a word length of 2^{24} (16.7 million) possible values per sample.

Sampling Rate

The 552 records WAV files at the sampling rates selected below. The sampling frequency is set in the Setup Menu.

- 44.1 kHz
- 48 kHz
- 88.2 kHz
- 96 kHz

Sound Devices recommends 48 kHz sampling for all 552 production applications. Sampling rate options are limited to 48 kHz and under when an MP3 or a Time Code to Track option is selected. If the sampling rate is set to a higher rate when an MP3 option or a Time Code to Track option is selected, the sampling rate defaults to 48 kHz.

Sampling Frequency and Audio Bandwidth

The sampling frequency is expressed in samples per second (hertz) and defines the number of times in a second that an analog audio signal is measured. Sampling frequency determines the audio band-

width, or frequency response, that can be represented by the digital signal. To roughly estimate the maximum bandwidth available for recording divide the sampling frequency by two.

Recording Media

The 552 records to a removable Secure Digital High Capacity (SD or SDHC) media. SD cards compatible with the 552 require FAT32 formatting. To format media from the 552, press and hold the following buttons in order:

- Stop key
- Battery Check Button
- Headphone Controller

Immediately following the above button sequence, SVEN announces “Formatting SD Card. Press Battery Button if ok, press Stop to cancel.” To proceed with the formatting process, press the Battery Check Button. To cancel, press the Stop key. If neither button is pressed in five seconds, formatting is canceled.

When formatting, SVEN announces “Formatting please wait” and the REC LED illuminates a constant yellow. Wait until SVEN announces “Formatting complete” and the LED turns off before performing any other action.

Multi Media Cards (MMC) and Secure Digital eXtreme Capacity (SDXC) cards are not supported and are not recognized by the 552.

After recording, the SD/SDHC card can be mounted to Mac or Windows based computers using a SD Card Reader. The card will appear as a mass storage device and its contents can be copied to another storage device.

The SD slot is located on the 552’s Rear Panel. It is protected by a rubber cover. Gently pry the protective rubber cover from left to right to expose the SD Slot. Insert the SD card into the slot. The card should glide smoothly into the slot. **DO NOT USE EXCESSIVE FORCE.** Push the card so that it seats securely in the slot. To remove, push the card in to eject it then pull it out of the slot.

Press and hold the Battery Check button to hear remaining card space available on the inserted SD card. SVEN automatically announces the remaining time when 15, 10, 5, and 2 minutes are remaining on the SD card.

Folder Structure

The 552 automatically generates a new Daily Folder when a recording is started. These folders are named according to the current date, derived from the 552's Time and Date Clock. A daily folder generated on October 15, 2009 would be named 09Y10M15. Sound files recorded by the 552 are always recorded to its own day's daily folder.

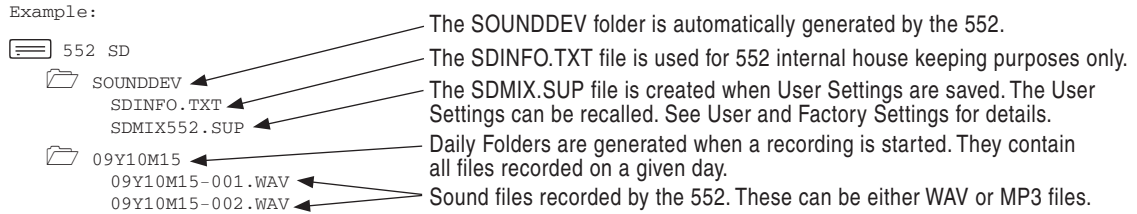

File Naming

Audio files recorded by the 552 are named according to the current date and a three digit file/take number. The file number increments with each new recording. For Example, the first file recorded on October 15, 2009 will be named 09Y10M15-001.WAV the next file recorded is named 09Y10M15-002.WAV and so on.

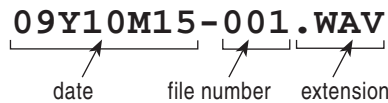

The file number is reset to 001 when a new daily folder is generated. 552 generated files are placed in a daily folder at the root of the inserted SD/SDHC card. While in stand-by mode, press in on the Recorder Controller to hear the next file number to be recorded.

The Take Counter (file number) can be reset to 001 at anytime. To reset the Take Counter, hold PFL 5 then press the Stop and Battery Check buttons. If the Take Counter is reset in the middle of the day and there are still files residing in the daily folder, it is possible to get duplicate file names. The 552 automatically detects if the folder has a file of the same name and will add an A after the take number (09Y10M15-001A.WAV) to prevent accidental overwriting of the original file.

Automatic File Splitting

While it is possible to have thousands of files on the 552 SD card, the largest any single file may be is 2 GB. The 552 automatically splits an audio file before the 2 GB size is reached and begins writing to a new file. When joined in an editing program, these files are sample-continuous, with no samples lost.

Recorder Controller

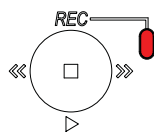

The 5-position Recorder Controller is used to perform all recording and playback functions.

Function	Direction	Action
Record		Push the Recorder Controller Up In Standby, begins recording a file. If recording, begins recording a new file.
Record/Pause Stop		Press the Recorder Controller Action is dependent on Record Pause setting. When Record Pause is on, press once to pause the recording, press again to stop. When Record Pause is off, press once to stop. During Playback, press once to pause, press again to stop.
Play		Push the Recorder Controller Down Begins playback of the last take recorded or file currently loaded. Playback is sent the headphone monitor only.
Rewind/ Load Previous Take		Push the Recorder Controller Left While in Stand-by, push left to load the previous take. While in playback, push and hold left to rewind.
Fast Forward/ Load Next Take		Push the Recorder Controller Right While in Stand-by, push right to load the next take. While in playback, push and hold right to fast forward.
Load Previous Daily Folder		Hold the Battery Check button and Push the Recorder Controller Left Loads the previous daily folder for playback.
Load Next Daily		Hold the Battery Check button and Push the Recorder Controller Right Loads the next daily folder for playback.
Playback Audio to L, R Outputs		Hold the Battery Check button and Push the Recorder Controller Down Playback audio is sent to the Left and Right Outputs.
Next File Number		Press the Recorder Controller While in Stand-by SVEN announces the file number of the next file to be recorded.

REC LED

The Record LED indicates the overall media status. When no media is present or detected the LED flashes yellow. The LED will be off when media is attached and ready. When the 552 is actively recording the LED illuminates solid red. When recording is paused or in the event that a record command is given and the media is not ready, the LED flashes red until the recorder actively starts recording. A solid yellow LED indicates the media is busy. The LED illuminates solid green while in playback mode and flashes green when playback is paused. The LED remains off when the recorder is disabled in the Setup Menu.

Record Mode

The REC LED illuminates solid red while recording. The start of a recording is indicated audibly in headphones by a single, 440 Hz tone. When a recording is paused, one 220 Hz tone is heard in headphones and the REC LED flashes red. *See Record Pause for details.* When recording is stopped, two 220 Hz tones are heard in headphones. The Setup Menu is locked out while recording.

The 552 can be set to automatically start and stop recordings according to the incoming time code signal. *See Time Code for details.*

If the internal batteries drop to extremely low voltage levels while recording, the recorder will automatically close the file that it is recording to prevent it from being lost. The recorder is locked out until the power source is switched to external or the 552 is powered down and batteries are changed.

Record Pause

When Record Pause is enabled in the Setup Menu, the recordings can be stopped then continued without creating a new file. Record Pause is useful for reporter interviews or any application that can benefit by stopping and starting recording without generating a new file. To use the Record Pause feature:

1. Enter the Setup Menu. Press and hold the Battery Check button then press the Headphone Controller.
2. Navigate to the Setup Menu Function Record Pause (-18 LED on the Left Meter). Turn the Headphone Controller to move through Setup Menu Functions. SVEN announces each function as you step through the menu.
3. Enter the Setup Menu Function Record Pause (-18). Press the Headphone Controller to select a function.
4. Navigate among the available options. SVEN announces each available routing as you step through the available options.
5. Select On (-24). Press the Headphone Controller to select an option. This will exit the selected Setup Menu Function.
6. Exit the Setup Menu. Press any key other than the Headphone Controller to exit the Setup Menu.
7. Press the REC key to begin recording.
8. Pause the recording at any time by pressing the STOP key once. When paused the REC LED flashes red.
9. Press the REC key again to continue recording.
10. Press the STOP key twice to finalize the recording. At this point, the file is available for Playback and the next press of the REC key begins recording the next incremented take.

Please note that the Record Pause behavior will vary depending on the set Time Code mode. When Time Code is set to Stamp File or Stamp File Auto Record, the Record Pause feature is ignored. This prevents the event of offsets in time code. Record Pause is available when Time Code is set to Replace Left and Replace Right. This allows linear time code to be recorded to one of the audio tracks. When set to Auto Record Replace Left or Auto Record Replace Right, the 552 begins recording when the time code signal advances. When time code becomes stationary, the 552 stops and closes the file. If the recording is manually stopped by pressing the stop button the recording is paused. If time code is stopped then started again the recording continues recording. Press Stop twice at anytime to stop and close the file. *See Time Code for details.*

Time Code

Time Code Mode is set off at factory default. When Time Code Mode is set to off the 552 stamps a start time code value that is derived from the time-of-day clock to the "BEXT" chunk of the recorded WAV file and no frame rate information is written. When Time Code Mode is off, no time code information is written to the "iXML" chunk of the recorded WAV file. MP3 files will have the start time

code value (Derived from the time-of-day clock) and a frame rate of 30ND stamped when time code mode is set to off.

When time Code Mode is set to something other than off and valid time code is present at the RTN B TA3 connector, time code values and frame rates are written to the file at the moment the recording begins. This allows the Sound Mixer to sync the audio recorded by the 552 with the master source.

Incoming Time Code signals must be running prior to pressing record to ensure proper frame rate and time stamps. Time Code stamping is only performed at the moment record is pressed. If the time code source is not running at the moment record is pressed, the 552 stamps the file according to the stationary time code that it is receiving. When Time Code is enabled, RTN B monitoring and functionality only apply to the 3.5 mm RTN B jack.

When Time Code Mode is set to something other than off the TC In LED will illuminate solid blue if valid time code is present at the RTN B TA3 input connector. A flashing blue TC In LED indicates that Time Code mode is set to something other than off but there is not valid time code present at the RTN B TA3 connector.

Time Code to Track

The linear time code signal connected to the RTN B TA3 input connector is recorded when either the Replace Left or Replace Right options are selected in the Time Code Setup Menu. The linear time code signal overrides the selected side of the AES A Source sent to the Recorder.

Replace Left, Replace Right, Replace Left Auto Record, and Replace Right Auto Record modes are only available with 44.1 and 48 kHz sampling rates. When the sampling rate is set to 88.2 or 96 kHz and one of the Time Code to Track modes is selected the sampling rate is forced to 48 kHz.

The 552 prevents sending time code signals written to track to the outputs and the headphone monitor. The REC SOURCE headphone monitor selection continues to monitor the AES A Source when a Time Code to Track option is selected. Time Code recorded to Track is muted while playing back the file from the 552.

External Time Code Auto Record

The 552 can be set to automatically start and stop recordings according to the incoming time code signal when anyone of the Auto Record modes is selected in the Time Code Setup Menu. The 552 enters record as the external time code advances, and the recording is stopped when the external code is stationary. This is appropriate when dual-system sound is used with video cameras set for Rec Run time code. The video camera functions as master time code and the 552 recorder “transport” follows the video camera transport.

Playback

After a file has been recorded, the 552 can play back the file. The last file recorded is always the file that is immediately available for playback. Playback audio is sent to the headphone monitor. The Headphone Selector position determines the monitoring behavior. ST = Left and Right Stereo, M = Left and Right Mono, L = Left Mono, R = Right Mono, MS ST = Mid Side Stereo Decoded, and REC SOURCE = Left and Right Stereo. The LED meter display indicates headphone monitor activity.

To navigate among files for playback, press the rewind and fast forward keys while playback is stopped. To navigate among daily folders, press and hold the Battery Check button and press Rewind or Fast Forward to go to the previous or next day’s folder respectively. As a file or folder is loaded a short beep is sent to the headphone monitor followed by the file number or day of the folder.

To playback a file, push the Record Controller down toward the Play position. To pause playback, press the Record Controller. To Stop playback, press the Record Controller twice. To Rewind or Fast Forward through a file, press and hold the Record Controller to the left or right respectively while the file is playing back.

By default playback audio is only sent to the headphone monitor. To send the playback audio to the Left and Right Outputs, press and hold Battery Check then press Play. After the file is stopped the outputs will return to normal program.

Metering

The 552 features two large 21-segment LED output meters. The meters use energy-efficient GaN LEDs, which can be clearly seen in full sunlight. The 552 output meters are unaffected by shock, temperature, or humidity extremes. The microcontroller-based meters provide a selection of ballistics and lighting intensities.

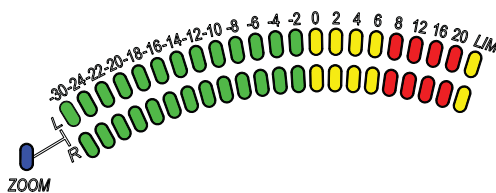

Meter Ballistics

The output meters display any of five types of meter ballistics: VU, Peak, Peak and Peak Hold, a composite of VU and Peak, and a composite of Peak Hold and VU. Meter ballistics are set in the Setup Menu. *See the Setup Menu.*

VU

VU (volume units) meter ballistics correspond closely to how the human ear perceives loudness. This provides a good visual indication of how loud a signal will be. In VU mode, the attack and decay of the meter signal is 300 mS. VU meters provide great visual indications of how loud a signal will be. However, VU meters provide poor information of actual signal peaks.

In VU mode, the front panel meter labeling is in volume units. VU meters are always referenced to an actual signal level in dBu, the 552 VU meter is referenced with 0 VU corresponding to 0 dBu at the Line-Level outputs. If needed, the reference level can be changed in the Setup Menu to +4 or +8 dBu.

Peak

Peak-reading ballistics (PPM) correspond to actual signal peaks, but don't necessarily correspond to perceived signal loudness. Peak meters have an instantaneous attack and a slow decay to allow the user to visually monitor peak activity. Peak metering is useful when interconnecting to audio inputs on digital equipment. In the digital realm, signal overload can cause immediate distortion.

The peak meter's front panel markings are calibrated in peak dBu level at the Line Level outputs.

Peak + Peak Hold

Peak-reading ballistics correspond to actual signal peaks, but the peak value is held in the meters for two seconds. Peak Hold indicators are useful for metering in applications when an overload condition is unacceptable.

Peak + VU

The 552 can simultaneously display VU and Peak level information. In this mode the perceived loudness (VU) is displayed on a bar graph, and the Peak signal on a dot above the VU. With this combi-

nation the user gets the best of both VU and Peak metering by seeing the “loudness” of the signal while observing peaks at the same time.

Peak Hold + VU

This is the default meter ballistics setting, it is a combination of Peak + VU and Peak Hold. The meter simultaneously displays the Peak and VU information while holding peak values for two seconds.

Zoom Metering

Zoom Mode allows the user to quickly display the output levels in 1 dB increments from 0 dBu to +20 dBu. Each LED represents a 1 dB change. While in Zoom Metering mode, the etched -30 LED is re-assigned to 0 dBu, the etched -24 is actually +1 dBu, and so on. Press the Headphone Controller to enter and exit Zoom Metering Mode. The blue Zoom LED indicates that the meter is in Zoom Metering Mode. Zoom Metering Mode can be disabled in the Setup Menu Function Metering Ballistics to prevent accidental activation.

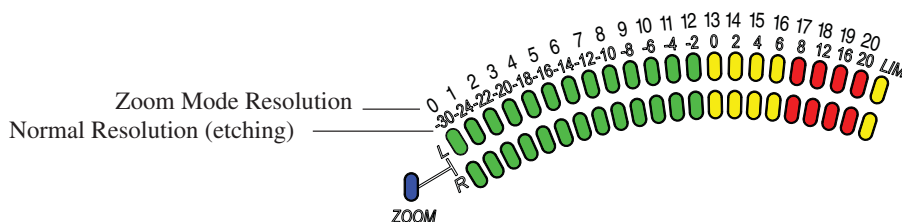

Input Activity LED

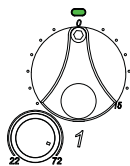

Each channel has its own Input Activity LED located just above the Input Fader. The LED illuminate in various colors and intensities to represent the signal level appearing at its respective input. Green = pre-fade signal activity, yellow = pre- and post-fader limiter activity, red = pre- and post-fader signal overload (peaking). Reduce the trim level control if the LEDs continuously illuminate yellow or red. The Input Activity LED will flash yellow when the Input PFL is latched on and illuminate solid red when the input is muted.

Headphone Peak LED

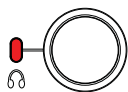

Like the Channel Peak LEDs, the headphone circuit also has a peak overload indicator. This LED is useful because headphones can often overload before overloading the 552's stereo output bus. Monitoring without a visual indication of headphone clipping can mislead the sound mixer into thinking that the output or return feeds are distorted.

Headphone Monitoring

Headphone Gain

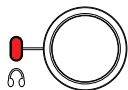

Headphone output level is controlled using the front panel Headphone Controller. While turning the Headphone Controller, the headphone gain level is temporarily displayed on the Right Output Meter.

The 552 can drive headphones to dangerously high volumes. Turn down the headphone gain before selecting a headphone source to prevent accidental signal extremes.

Headphone Source Selection



The Headphone Selector sets the audio source sent to headphones. The selections available are listed below:

HP Position	Description
ST	Stereo - Left program to left headphone monitor and Right program to right headphone monitor.
M	Mono - summed Left and Right program sent to both headphone monitors.
L	Left - Left program sent to both headphone monitors.
R	Right - Right program sent to both headphone monitors.
MS ST	Mid-Side Stereo - decoded MS stereo to headphones, this is not used if the inputs are already linked as an MS pair.
REC Source	Recorder Source - audio program sent to the recorder, this is identical to AES A routing. .

Headphone Tones

Record Start and Stop Tones

The start of a recording is indicated audibly by a single 440 Hz tone sent to headphones. When recording is stopped two 220 Hz tones are sent to the headphones.

Playback Navigation Tones

A single 220 Hz tone followed by an announcement of the time the file was created is sent to the headphones when a file is selected for playback using the Record Controller.

PFL (Channel Solo Monitor)



PFL (pre-fade listen) allows the user to quickly monitor the selected input's signal pre-fader, post-trim, post-high-pass, and post-limiter. Slide the PFL switch left to activate, and again to deactivate. For momentary action, hold the switch left for one second or longer.

The left meter indicates the signal level of the soloed channel. PFL monitoring only affects the headphone monitor, it does not affect audio sent to the outputs. The selected input's Activity LED flashes yellow when the input's PFL is latched on. PFL latching operation only allows for one input to be soloed at a time. To PFL multiple inputs, use momentary operation.

RTN A and B



The Return monitor switch has two positions, A and B. When switched to the left or A position, RTN A audio is sent to the headphones, taking precedence over the Headphone Source selection. Similarly, when held to the right or B position, RTN B audio is sent to the headphones. To latch on the return in the headphone monitor, slide the RTN switch towards the desired return, slide again to turn off. For momentary action, Hold the RTN switch for one second or longer.

The RTN A and RTN B LEDs illuminate in various colors and intensities to indicate signal presence, green = signal activity, red = RTN clipping. The LEDs illuminate solid yellow to indicate the respective return is latched on. To adjust the gain of a respective RTN, hold the RTN switch and turn the headphone controller.

Return audio can be sent directly to receiving devices using the Tape or Mono Mic outputs. [See Return Loopback for additional information.](#) The RTN B TA3 connector can also be used as a Time Code input. RTN B TA3 audio is disabled when time code is enabled. [See Time Code for additional information.](#)

Split Ear Return Monitoring

Split Ear Return Monitoring allows the user to monitor two sources at the same time. RTN A split ear monitoring sends the RTN A summed mono signal to the left headphone monitor and the Right program audio to the right headphone monitor. To activate RTN A split ear monitoring, press and hold the Headphone Controller then slide the RTN switch left to the A position. When RTN A Split Ear Monitoring is active the RTN A LED flashes yellow in a two pulse sequence.

RTN B split ear monitoring sends the RTN B summed mono signal to the right headphone monitor and the Left program audio to the left headphone monitor. To activate RTN B split ear monitoring, press and hold the Headphone Controller then slide the RTN switch right to the B position. When RTN B Split Ear Monitoring is active the RTN B LED flashes yellow in a two pulse sequence.

RTN A/B split ear monitoring sends the RTN A summed mono signal to the left headphone monitor and the RTN B summed mono signal to the right headphone monitor. To activate RTN A/B split ear monitoring, press and hold the headphone controller then slide the RTN switch left to the A position then right to the B position. Both RTN A and RTN B LEDs illuminate solid yellow when RTN A/B split ear monitoring is active.

Return Loopback

During typical operation the 552's Left and Right output buses are sent to both the Tape outputs and the Mono Mic output. When set, Return Loopback allows Return A or Return B to be directly routed to the Tape and Mono Mic outputs. To set Return Loopback Mode, press and hold the Battery Check button and slide the RTN A/B switch to the Return position. The respective return becomes the source for the Tape and Mono Mic outputs. To return to typical operation, press and hold the Battery Check button and slide the RTN A/B switch again. The respective RTN LED will flash yellow when Return Loopback is active.

Return Loopback is useful for sending an IFB wireless feed of the RTN audio to the producer for video playback.

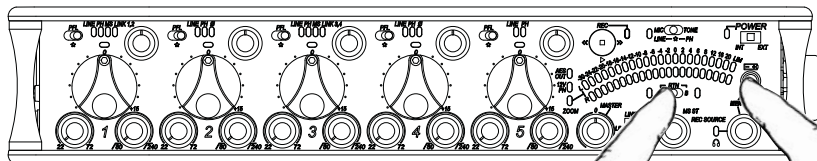

1. Press and hold the Battery Check button.
2. Slide the RTN A/B switch.



Powering

The 552 is powered by either internal batteries or external DC sources. The power switch selects the power source, either internal or external. There is a large enough power reserve to switch back and forth from one source to the other without interrupting mixer operation.

The 552 is a power-efficient device and can run from four-AA alkaline batteries for approximately eight hours (without phantom). As additional load is placed on the mixer, battery runtime is reduced. *See Power Consumption for details.*

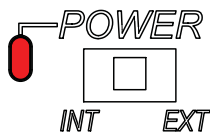

Internal Battery Powering

Internal batteries can be used as either a primary power source or as a back-up in the event that external power is removed or depleted. The 552 uses four AA-sized (LR6) batteries of various types. Lithium primary cells, Alkaline, and NiMH rechargeable AA battery types are all popular battery chemistries. The 552 achieves the longest battery runtime with Lithium and NiMH batteries.

There are similar sized 3+ V Lithium cells on the market which are not compatible with 552.

If the internal batteries drop to extremely low voltage levels while recording, the recorder will automatically close the file that it is recording to prevent it from being lost. The recorder is locked out until the power source is switched to external or the 552 is powered down and batteries are changed.

External Powering

The 552 can be powered from any DC voltage from 10 to 18 VDC. Pin-4 of the locking, Hirose connector is positive (+) and pin-1 is negative (-). The external DC supply is fully isolated (floating) from the rest of the mixer for easy and safe interconnection with other external audio gear.

Voltage Metering

Press and release the Battery Check button to display the voltage levels of the internal batteries and external power sources. The Left meter shows the internal battery voltage level; the right meter shows the external voltage level. Because many different power sources can be used for external powering, the external DC metering is customizable for different power sources in the Setup Menu.

The Power LED lights green for any voltage higher than the Warning Point. When the voltage level drops to the Warning Point, the power LED illuminates yellow (Internal power only). When the Low Voltage point is reached the LED flashes red until the power source is exhausted and unable to power the mixer.

Voltage Metering Chart	Setting	High Voltage	Warning Point	Low Voltage	Power Source
	1	13.0	11.5	11.0	12 V NiCad, NiMH. ← Factory Setting
	2	17.0	11.5	11.0	Expanded range of setting #1
	3	14.0	11.4	10.0	12 V Lead Acid
	4	17.0	11.5	5.0	Full range of DC input, w/ cutoff for 12 V NiCad, etc.
	5	16.3	13.5	12.5	14 V Li-ion rechargeables

Experimentation is recommended to determine battery life for each individual setup and application.

Power Consumption

The 552 varies in the amount of current it draws. Several features of the 552 directly affect current draw in different ways. The following list highlights the larger current drawing functions.

1. Microphone powering - the main source of extra 552 current draw. *See Phantom Power.* 48 V Phantom can draw copious amounts of current out of the batteries, depending on what model microphone is used. Two phantom powered microphones draw twice as much current as one. Microphones vary widely in their current draw depending on type and phantom voltage applied.
2. Integrated Audio Recorder - the recorder, whether in record or playback, increases power consumption. Turn Record Mode off in the Setup Menu when not in use to extend battery run times.
3. Digital Outputs - disable digital outputs in the Setup Menu when they are not needed since they draw additional current.
4. Output drive level - higher output drive levels into multiple, low-impedance inputs increases power consumption.
5. Headphone output circuit - high headphone output levels increase current draw.
6. LED Brightness - decrease LED brightness to extend battery runtime.

Slate Mic/Tone Oscillator

A single two-position switch controls both the slate microphone and the tone oscillator.

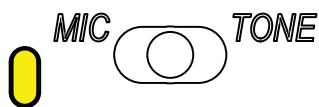

Slate Microphone

The built-in 552 slate microphone is used to notate scenes from the mixer location. Its audio performance is not suitable for critical recording applications; it should be used for documenting scenes and for communication purposes only.

The slate mic uses the left switch position. Slide the switch to the left to activate, and again to turn off. For momentary action, hold the switch to the left for 1 second or longer. The LED adjacent to the Mic/Tone switch will illuminate yellow when either Slate or Tone is latched on.

Program audio is muted while the slate mic is active. The signal is sent to all outputs and the Integrated Digital Audio Recorder. In the Setup Menu a one second, 400 Hz tone can be set to precede the slate microphone. Additionally, the slate mic can be disabled to prevent unintended activation.

The slate mic is used as a communication system between the Sound Mixer and a Boom Operator when using the Talk Back mode, selected in the Setup Menu. *See Talk Back Mode for more details.*

Tone Oscillator

Tone is used to set gain structure between the 552 and the next device in the signal path. The tone oscillator uses the right position of the slide switch. Slide right to activate, hold for two seconds to latch on. The LED adjacent to the Mic/Tone switch will illuminate yellow when either the Slate Mic or the Tone Oscillator is latched on.

From the factory, the tone oscillator is set to output a 1 kHz sine wave at 0 dBu to the outputs (when the outputs are set to Line Level). Tone is also sent at the same level to each of the Direct Outputs. Tone level and frequency settings are configured in the Setup Menu. The 552 headphone outputs are attenuated when tone is activated.

With Tone activated, press the Battery Check button to cycle the left output by -20 dB. This is used to verify left and right output signals. Turn off the tone oscillator or press the Battery Check button again to stop the output cycling.

Talk Back Mode

Talk Back Mode allows a Sound Mixer to have a private conversation with a Boom Operator using the 552 slate mic. When in Talk Back mode, **the Slate microphone is not routed to the 552 master outputs, direct outputs, or to the recorder.** The slate mic is sent only to the right channel of the 1/4-inch and 3.5 mm headphones.

In Talk Back mode, the two 552 headphone outputs contain two different audio sources. The 1/4-inch headphone output is used for the Sound Mixer's headphones. Audio sent to the 1/4-inch headphones is normal program. The 3.5 mm headphone output is used for the Boom Operator's headphones. Its audio source is menu-selected.

The audio signals sent to the 3.5 mm headphone output is set in the Setup Menu. Source is set as slate-only, slate + left program, or slate + channel 1 post-fade. The slate mic signal is sent to the right headphone output and is mixed with the program selected in the Talk Back Setup Menu Function.

Talk Back Option	3.5 mm Headphone Audio Source
Off - Normal Program	Standard headphone program, identical to 1/4-inch.
Slate Only	Active Slate Mic signal only, sent to the right headphone monitor.
Slate + Left Program	552 Left Program sent to both monitors and active Slate Mic Signal sent to the right headphone monitor.
Slate + Channel 1 Post-Fade	Channel 1 Post-Fader sent to both monitors and active Slate Mic Signal sent to the right headphone monitor.

To setup a communication system follow these steps.

1. Connect the 552 Sound Mixer's headphones to the 1/4-inch headphone jack.
2. Connect the Boom Operator's headphones to the 3.5 mm headphone jack.
3. Enter the Setup Menu. Press and hold the Battery Check button then press the Headphone Controller.
4. Navigate to the Setup Menu Function Talk Back (0 LED on the Left meter). Turn the Headphone Controller to move through Setup Menu Functions. SVEN announces each function as you step through the menu.
5. Enter the Setup Menu Function Talk Back (0 LED). Press the Headphone Controller to enter a function.
6. Navigate among the available options. SVEN announces each option as you step through the menu.
7. Select the option best suited for your particular application. Press the Headphone Controller to select an option. This will exit the Setup Menu Function.
8. Exit the Setup Menu. Press any key other than the Headphone Controller to exit the Setup Menu.

When in Talk Back mode, the 3.5 mm headphone jack has its own dedicated gain. To set levels, hold the Slate switch and turn the Headphone Controller. In Talk Back mode, press and hold the Battery Check button and the Slate switch to use the slate as an "all call". This temporarily returns the Slate Mic to normal operation. That is, regular program audio will be muted and the slate mic signal will be sent to all outputs. If the slate mic is disabled in the Setup Menu, the "all call" is also disabled.

The following diagram illustrates a wireless Talk Back setup using a Sound Devices MM-1.

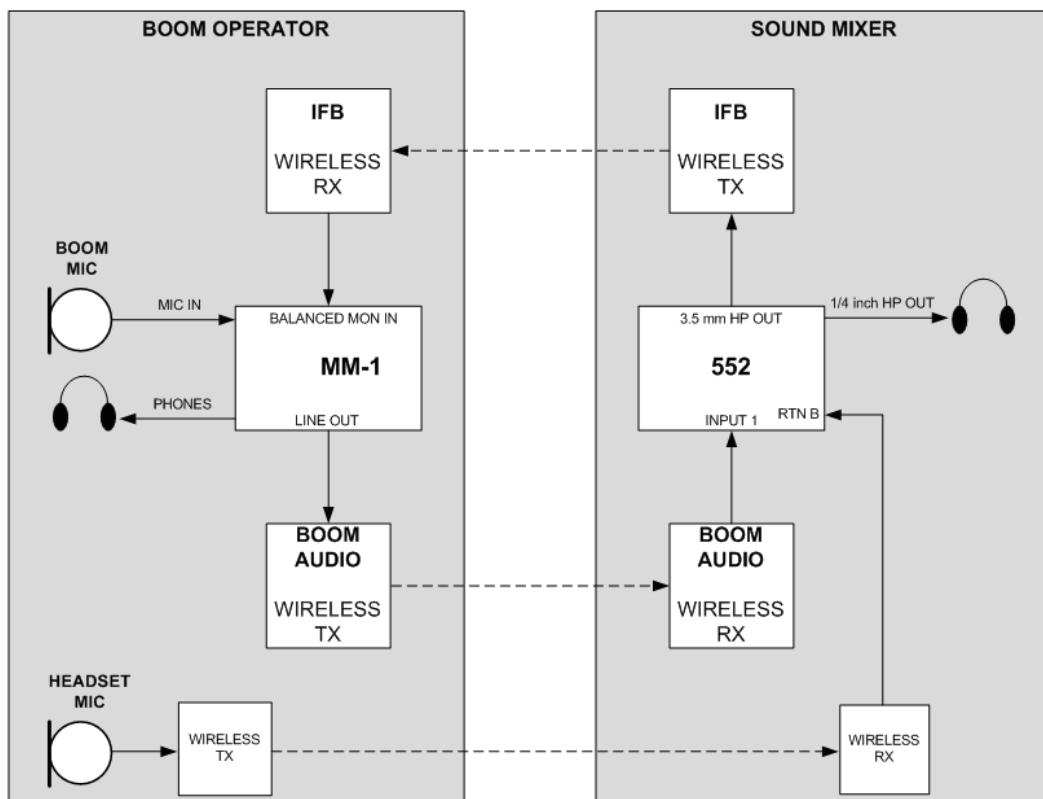

Time of Day/Date Clock

The 552 has a built-in time-of-day/date clock used to stamp recorded files with the time recorded. All clock references are in 24-hour format.

To check the current time, press-and-hold the Battery Check button. If an SD card is inserted, the Remaining Record Time will precede the Time and Date announcement.

To set the Time and Date Clock follow these steps:

1. Enter the Time Date Set Menu by holding Input 5's PFL switch then press the Battery Check button and the Headphone Controller. SVEN announces "Time Date Set" when in the menu. While in the menu, at anytime press the Battery Check button to exit the Time Date Set Menu. SVEN announces the new time and date information when exiting the Time Date Set Menu.
2. The first unit of time to be edited is the hour. SVEN announces "Hours" followed by the currently selected value. To change the value turn the Headphone Controller. SVEN announces each value as you step through the menu. Values are also indicated by the number of LEDs lit. The left meter indicates tens and the right meter indicates units. For example, if it is the 13th hour (1pm) the left meter -30 LED (1 LED) and right meter -30 to -22 LEDs (3 LEDs total) are lit.

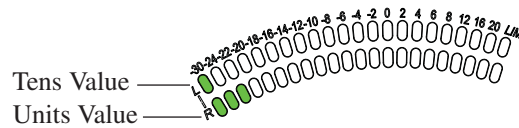

3. Press the Headphone Controller to save the selection and advance to the next unit of time.
4. The next unit of time to be edited is Minutes. SVEN announces "Minutes" followed by the currently selected value. Make appropriate edits using the same method as described in step 2.
5. Press the Headphone Controller to save the selection and advance to the next unit of time.
6. The next unit of time to be edited is Seconds. SVEN announces "Seconds" followed by the currently selected value. Make appropriate edits using the same method as described in step 2.
7. Press the Headphone Controller to save the selection and advance to the next unit of time.
8. The next unit of time to be edited is Month. SVEN announces "Month" followed by the name of the currently selected month. Make appropriate edits using the same method as described in step 2.
9. Press the Headphone Controller to save the selection and advance to the next unit of time.
10. The next unit of time to be edited is Day. SVEN announces "Day" followed by the currently selected value. Make appropriate edits using the same method as described in step 2.
11. Press the Headphone Controller to save the selection and advance to the next unit of time.
12. The next unit of time to be edited is Year. SVEN announces "Year" followed by the currently selected value. Make appropriate edits using the same method as described in step 2.
13. Press the Headphone Controller to save the selection and exit the Time Date Set Menu. SVEN announces the new time and date information when exiting the Time Date Set Menu.

Mixer Linking

Linking 552 Mixers

The Link I/O function allows two 552s to be interconnected for applications requiring more inputs. When 552s are linked, all ten inputs appear at both mixer's outputs. Return audio and PFL occur on the headphone output of both mixers. The Link I/O connector is an unbalanced TA5M wired pin-1 = HP L, pin-2 = HP R, pin-3 = Mix R, pin-4 = Mix L, pin-5 = link detection/ground.

To Link two 552s together:

1. Connect the Link I/O of 552 A to the Link I/O of 552 B using a TA5F to TA5F cable (Sound Devices XL-TA55 optional accessory). This will send the stereo mix of each 552 directly to the stereo output bus of both 552s.



2. Monitor the stereo sum of all ten input channels from either 552 headphone monitor.
3. Adjust the levels on each mixer accordingly.

Linking to Other Mixers

The Link I/O function allows the 552 to be linked to a Sound Devices 302, 442, or MixPre mixer for applications requiring higher input channel counts. When the 552 is linked with another Sound Devices mixer, all input channels will be present on the stereo outputs of the 552. Return audio and PFL only occur on the headphone output of the mixer that it is performed on. The 552 Link I/O connector is an unbalanced TA5M wired pin-1 = HP L, pin-2 = HP R, pin-3 = Mix R, pin-4 = Mix L, pin-5 = Link detection/ground.

Linking to a 302 or 442

The Tape Out/Mix Out of a 302 is an unbalanced stereo TA3F connector wired pin-1 = ground, pin-2 = Left, pin-3 = Right. The 442 has two Tape Out/Mix Out connectors, 3.5 mm and TA3. For the most secure connection use the TA3 Tape Out/Mix Out connector. The TA3 is wired pin-1 = ground, pin-2 = Left, pin-3 = Right. *For details on the 3.5 mm connection see Linking to a MixPre.*

Sound Devices XL-TA35 is a 12-inch, TA5F to TA3F accessory cable used to link Sound Devices 302 and 442 mixers to the 552. *For more details see Accessories.*

To link a Sound Devices 302 or 442 to a 552:

1. Connect the Link I/O of the 552 to the Tape Out/Mix Out of a 302 or 442 using a Sound Devices XL-TA35 cable. This sends the stereo mix of both mixers directly to the stereo output bus of the 552.



2. Monitor the stereo sum of all input channels from the 552 ST headphone monitor.
3. Adjust the levels on each mixer accordingly.

Linking to a MixPre

The MixPre's Tape Out 3.5 mm TRS is wired Tip = Left, Ring = Right, Sleeve = ground. Sound Devices XL-TA25 is a 20-inch, TA5F to 3.5 mm TRS accessory cable used to link Sound Devices MixPre to the 552. *For more details see Accessories.*

To link a Sound Devices MixPre to a 552.

1. Connect the Link I/O of the 552 to the Tape Out of a MixPre using a Sound Devices XL-TA25. This sends the stereo mix of both mixers directly to the stereo output bus of the 552.



2. Monitor the stereo sum of all input channels from the 552 headphone monitor.
3. Adjust the levels on each mixer accordingly.

Accessing the Setup Menu

The Setup Menu controls a wide range of 552 settings. To enter the Setup Menu, press and hold the Battery Check button then press the Headphone Controller. Turn the Headphone Controller to scroll through the menu. Press the Headphone Controller to enter Functions and to select options. To exit the Setup Menu, press any key other than the Headphone Controller. The Setup Menu is locked out while record mode is active.

1. Press and hold the Battery Check Button.
2. Press in on the Headphone Controller.

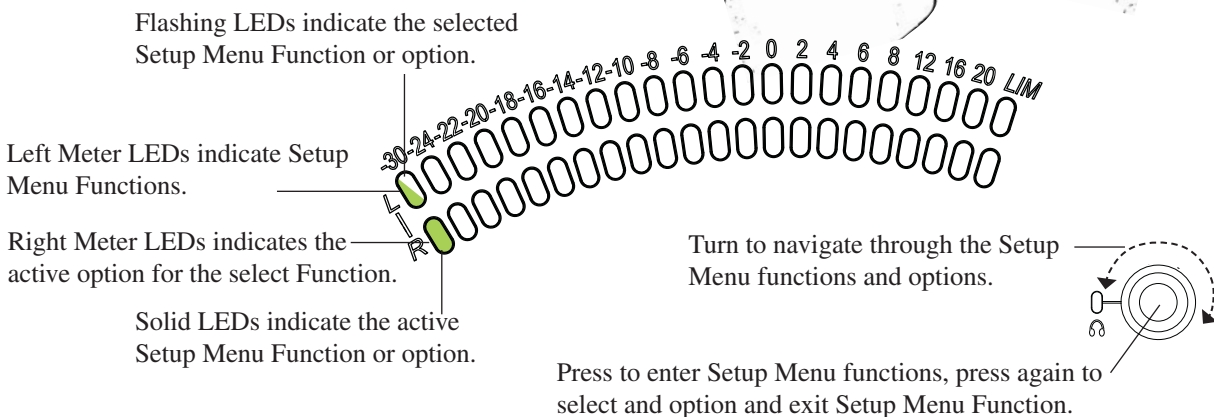
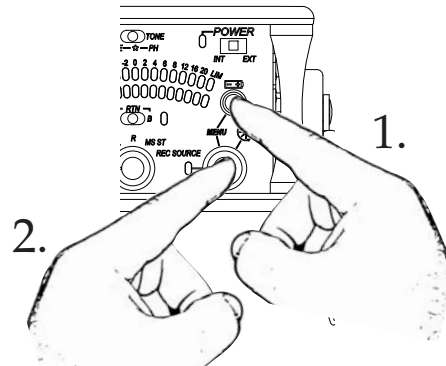

User Settings

The 552 can save and recall a User Setup File. To save a User Setup File, hold Input 1's PFL then press the Stop button. SVEN announces "Save Settings. Press Battery Button if ok, press Stop to cancel." To proceed with the saving user settings, press the Battery Check Button. To cancel, press the Stop key. If neither button is pressed in five seconds, the save settings function is canceled. When saving, the REC LED illuminates a constant yellow. Wait until SVEN announces "Save complete" and the LED turns off before performing any other action.

The Setup File is named SDMIX552.SUP and is placed in the SOUNDDEV folder on the SD card. User Setup Files contain all settings made in the Setup Menu and all Input Settings including, input type, phantom power, and polarity.

To load a User Setup File, hold Input 1's PFL then press the Headphone Controller. SVEN announces "Load Settings. Press Battery Button if ok, press Stop to cancel." To proceed with loading user settings, press the Battery Check Button. To cancel, press the Stop key. If neither button is pressed in five seconds, the load settings function is canceled. If loading user settings, wait until SVEN announces "Load complete" before performing any other action.

Factory Default Settings

To restore Factory Default Settings, hold Input 4's PFL, then press the Headphone Controller and the Battery Check button. SVEN announces "Load Factory Defaults. Press Battery Button if ok, press Stop to cancel." To proceed with loading factory defaults, press the Battery Check Button. To cancel,

press the Stop key. If neither button is pressed in five seconds, the load settings function is canceled. If loading factory defaults, wait until SVEN announces “Load success” before performing any other action.

Loading Factory Settings reverts all input settings to factory default. All inputs will return to Line level with no phantom power and normal polarity.

Setup Menu Chart

The chart below shows the Setup Menu number, Function name, a description of the control, options available within that menu, and the factory default setting. Factory Default settings are always the first LED position on the right meter (-30 LED).















LED	Function	Description	Options	Factory Default
-30	Output Limiter Threshold	Sets the output limiter threshold in dBu.	+4 to +20 dBu in 1 dB increments at Line Level output	+20
-24	Balanced TA3 Outputs	Selects the nominal output level of the active balanced TA3 Left and Right Outputs.	<ul style="list-style-type: none"> • Line (-30) • -10 (-24) • Mic (-22) 	Line
-22	Direct Outputs	Selects program and nominal output level for the TA3 Direct Outputs.	<ul style="list-style-type: none"> • Line Level / Pre-Fade (-30) • Line Level / Post-Fade (-24) • -10 / Pre-Fade (-22) • -10 / Post-Fade (-20) • Mic Level / Pre-Fade (-18) • Mic Level / Post-Fade (-16) 	Line / Pre-Fade
-20	Record Mode	Enables/disables the Integrated Digital Audio Recorder. Selection determines the file format and the bit depth or data rate of files to be recorded. Sampling rate is limited to 48 kHz and under when set to MP3. Sampling rate is forced to change if set to higher sampling rates when selecting MP3.	<ul style="list-style-type: none"> • 24-Bit WAV (-30) • 16-Bit WAV (-24) • 64k MP3 (-22) • 128k MP3 (-20) • 192k MP3 (-18) • 320k MP3 (-16) • Off (-14) 	24 Bit WAV
-18	Record Pause	Allows a recording to be stopped then continued without creating a new take or file. Record Pause is ignored when the Time Code function is set to a Stamp File option.	<ul style="list-style-type: none"> • Off (-30) • On (-24) 	Off
-16	Sample Rate	Sets the sampling rate for recordings and digital outputs. Sampling rate is limited to 48 kHz and under when set to record mp3 files.	<ul style="list-style-type: none"> • 48 kHz (-30) • 44.1 kHz (-24) • 88.2 kHz (-22) • 96 kHz (-20) 	48 kHz
-14	Time Code	Enables Time Code mode. Connect Time Code to RTN B TA3 connector. Time Code values are stamped within a recorded file. Time Code is recorded to an audio track when Replace Left or Replace Right is selected. Time Code to Track options force sampling rate to 48 kHz if set to higher sampling rates. In Auto Record modes, the 552 automatically starts and stops recordings when external time code advances.	<ul style="list-style-type: none"> • Off (-30) • Stamp File (-24) • Replace Left (-22) • Replace Right (-20) • Stamp file Auto Record (-18) • Replace Left Auto Record (-16) • Replace Right Auto Record (-14) 	Off

LED	Function	Description	Options	Factory Default
-12	Digital Output	Enables digital outputs and routes AES3 pairs to the XLR or 10-Pin outputs. AES A uses Left XLR or 10-Pin Connector. AES B uses Right XLR or 10-Pin. The connector's Level Switch should be set to Line-Level.	<ul style="list-style-type: none"> • All Off (-30) • AES A XLR (-24) • AES B XLR (-22) • Both XLR On (-20) • AES A 10-Pin (-18) • AES B 10-Pin (-16) • Both 10-Pin On (-14) 	All Off
-10	AES A Source	Selects the source for AES A. The selected source is the program sent to the Recorder and the AES A Digital Output (Left XLR), if enabled.	<ul style="list-style-type: none"> • Left, Right Program (-30) • Inputs 1, 2 Pre-Fade (-24) • Inputs 1, 2 Post-Fade (-22) • Inputs 3, 4 Pre-Fade (-20) • Inputs 3, 4 Post-Fade (-18) • Input 5 Pre-Fade, Left Program (-16) • Input 1 Pre-Fade, Left Program (-14) • Input 1 Pre-Fade, Left/Right Mono Program (-12) 	L,R Program
-8	AES B Source	Selects the source for AES B. The selected source is the program sent to the AES B Digital Output (Right XLR), if enabled.	<ul style="list-style-type: none"> • Left, Right Program (-30) • Inputs 1, 2 Pre-Fade (-24) • Inputs 1, 2 Post-Fade (-22) • Inputs 3, 4 Pre-Fade (-20) • Inputs 3, 4 Post-Fade (-18) • Input 5 Pre-Fade, Left Program (-16) • Input 1 Pre-Fade, Left Program (-14) • Input 5 Pre-Fade, Left/Right Mono Program (-12) 	L,R Output
-6	Phantom Voltage	Sets the phantom power voltage to be applied to all inputs. When 12 V is selected the overall power consumption of the 552 is lowered. Line options allow phantom to be applied to both Mic- and Line-Level inputs. Using phantom power on microphones at Line-Level is useful in high SPL environments. Make certain to disable phantom power with Line-level output devices susceptible to damage from DC.	<ul style="list-style-type: none"> • 48 Volts (-30) • 12 Volts (-24) • 48 Volts Line (-22) • 12 Volts Line (-20) 	48 Volts
-4	Input Linking	Selects input linking for channels 1,2 and 3,4. Inputs can be linked as stereo or MS pairs.	<ul style="list-style-type: none"> • Unlinked (-30) • Inputs 1,2 Stereo (-24) • Inputs 1,2 MS (-22) • Inputs 3,4 Stereo (-20) • Inputs 3,4 MS (-18) • Inputs 1,2 Stereo and 3,4 Stereo (-16) • Input 1,2 MS and 3,4 MS (-14) • Input 1,2 Stereo and 3,4 MS (-12) • Input 1,2 MS and 3,4 Stereo (-10) 	Unlinked
-2	Slate Mic	Enables/disables the Slate Mic switch. Tone + Slate option adds a 400 Hz tone when slate is activated.	<ul style="list-style-type: none"> • On (-30) • Tone + Slate (-24) • Off (-22) 	On
0	Talk Back	Allows 3.5 mm headphone jack to be used as a communication link. Slate appears in right ear only and is mixed with select audio. Slate is only sent to 1/4" and 3.5 mm headphones.	<ul style="list-style-type: none"> • Off (-30) • Slate Only (-24) • Slate plus Left Program (-22) • Slate plus Input 1 Post-Fade (-20) 	Off
2	Meter Reference Level	Selects 0 VU to dBu reference	<ul style="list-style-type: none"> • 0 dBu VU (-30) • +4 dBu VU (-24) • +8 dBu VU (-22) • +1 dBu VU / Peak (-20) • +2 dBu VU / Peak (-18) • +3 dBu VU / Peak (-16) • +4 dBu VU / Peak (-14) • +5 dBu VU / Peak (-12) • +6 dBu VU / Peak (-10) • +7 dBu VU / Peak (-8) • +8 dBu VU / Peak (-6) 	0 dBu VU

LED	Function	Description	Options	Factory Default
4	Meter Ballistics	Selects the metering ballistics of the Output Meter. When a No Zoom option is selected, the front panel zoom function is disabled. This prevents accidental activation. When on, press the Headphone Controller to enter Zoom Mode. .	<ul style="list-style-type: none"> • Peak Hold plus VU(-30) • Peak Only (-24) • VU Only (-22) • Peak plus Peak Hold (-20) • Peak plus VU (-18) • Peak Hold plus VU No Zoom (-16) • Peak Only No Zoom (-14) • VU Only No Zoom (-12) • Peak plus Peak Hold No Zoom (-10) • Peak plus VU No Zoom (-8) 	Peak Hold plus VU
6	Return Metering	Selects whether or not RTN signal activity is displayed on the Output Meter when a RTN is active.	<ul style="list-style-type: none"> • On (-30) • Off (-24) 	On
8	Tone Frequency	Selects the frequency (<i>f</i>) of the sine wave setup tone oscillator.	<ul style="list-style-type: none"> • 1000 Hz (-30) • 400 Hz (-24) • 100 Hz (-22) 	1000 Hz
12	Tone Level	Selects the output level of the tone oscillator in dBu.	<ul style="list-style-type: none"> • 0 dBu (-30) • Off (-24) • -20 dBu (-22) • -10 dBu (-20) to +8 dBu (20) in 1 dB increments 	0 dBu
16	External DC Reference	Selects the range for external power voltage measurement. Determines external power metering, warning level, and low voltage level.	<ul style="list-style-type: none"> • 12 Volt Ni Cad (-30) • 12 Volt Ni Cad Wide (-24) • 12 Volt Lead Acid (-22) • Full range DC Input (-20) • 14 Volt Lithium Ion (-18) 	12 Volt Ni Cad

Front Panel Button Shortcuts













To speed navigation the 552 has numerous navigation “shortcuts”. For combinations, press and hold down the first identified key then press the next identified key(s).

Function	Key Sequence	Action
Setup Menu	 + 	Press and hold the Battery Check button then press the Headphone Controller Enters the Setup Menu.
Card Space Available/ Time and Date		Press and hold the Battery Check button Announces the remaining card space available (if inserted). Continue to hold the button to hear the current Time and Date.
Time Date Set	 +  + 	Hold PFL 5, press Battery Check button, and press the Headphone Controller Enters Time Date Set menu.
LED Brightness	 + 	Hold the Battery Check button and turn the Headphone Controller Adjusts the brightness level of all front panel LEDs.
Meter Zoom		Press the Headphone Controller Toggles Meter Zoom on and off. When on, the resolution of the Output Meter is increased and ranges from 0 to 20 dB.
3.5 mm HP Gain (Talk Back Mode Only)	 + 	Slide the Slate Mic/Tone Switch Slate position and turn the Headphone Controller Adjusts the 3.5 mm headphone level in Talk Back mode.
All Call (Talk Back Mode Only)	 + 	Press and hold the Battery Check button and slide the Slate Mic/Tone Switch to the Tone position Temporarily returns the Slate Mic to normal operation when in Talk Back mode.
Playback Folder Navigation	 + 	Hold the Battery Check button and push the Recorder Controller to the Rewind and Fast Forward positions. Loads the previous or next daily folder respectively for playback.

Function	Key Sequence	Action
Playback to Outputs		Hold the Battery Check button and push the Recorder Controller to the Play position Sends Playback program to the Left and Right Outputs.
Mic / Line		Hold PFL and slide the Slate Mic/Tone Switch to the Slate position Toggles between Mic and Line level for the select input.
Phantom Power		Hold PFL and slide the Slate Mic/Tone Switch to the Tone position Toggles phantom power on and off for the select input.
Polarity Reverse Channel 2 and 4		Hold PFL (Channels 2 and 4 only) and press the Battery Check button Reverses the polarity of channel 2 and 4.
Input Mute		Press and hold the headphone controller then press the PFL Toggles input muting for the select Input
RTN Level		Slide the RTN Switch to the RTN A or RTN B position and turn the Headphone Controller Adjusts the RTN level.
RTN Split Ear Monitoring		Press and hold the Headphone Controller then Slide the RTN Switch to the RTN A or RTN B position When RTN A is selected, a summed RTN A signal is sent to the left headphone output, and the Right Master Output is sent to the right headphone output. When RTN B is selected, a summed RTN B signal is sent to the right headphone output, and the Left Master Output is sent to the left headphone output.
RTN A/B Split Ear Monitoring		Press and hold the Headphone Controller, slide the RTN Switch to the RTN A, then RTN B positions A summed RTN A signal is sent to the left headphone output and a summed RTN B signal is sent to the right headphone output.
RTN Loopback		Press and hold the Battery Check button then Slide the RTN Switch to the RTN A or RTN B position Sends the select return signal directly to the Tape and Mono Mic outputs.
Left Output Tone Identification		Hold the Slate Mic/Tone Switch in the Tone position and press the Battery Check Button Cycles the Left Output Tone Oscillator by 20 dB.
Next File		Press the Recorder Controller Announces next file number to be recorded.
Reset Take Counter		Hold PFL 5, press the Stop and Battery Check buttons Resets the take number to 001.
SD Card Format (Erase)		Press Stop, Headphone Controller, and Battery Check buttons Formats SD media. REC LED will flash then illuminate solid yellow, wait until light goes out before performing any other action.
Save User Setup		Hold PFL 1 and press the Stop button Saves User Settings to SD Media.
Load User Setup		Hold PFL 1 and press the Headphone Controller Recalls User Settings from SD Media.
Load Factory Settings		Hold PFL 4 and press the Headphone Controller and the Battery Check button Restores all Setup Menu parameters to Factory Default.

Connector Pin Assignments

Connector	Pin Assignments	Notes
XLR F Analog Inputs 1-5	 1 – ground 2 – signal (+) 3 – signal (-)	3.3k ohm input impedance, Mic- and Line-level Transformer Balanced. For unbalanced, pin 1 and pin 3 tied together = ground, pin 2 = positive.

Connector		Pin Assignments	Notes
TA3M Direct Outputs 1-4		1 – ground 2 – signal (+) 3 – signal (-)	Active balanced, output level is selectable in Setup Menu as Line, -10, or Mic level. For unbalanced, pin 1 = ground, pin 2 = positive, pin 3 = float (no connect). Mates with Switchcraft TA3F-type connector.
3.5 mm Mono Mic Output		tip – signal L and R sleeve – signal ground	Mates with 3.5 mm TS jack. Designed to interconnect Wireless IFB Transmitters and Transcription Recorders, signal is unbalanced.
3.5 mm Tape Output		tip – signal L ring – signal R sleeve – signal ground	Mates with 3.5 mm TRS jack. Signal is unbalanced.
XLR M Master Outputs/ AES A,B Outputs		1 – ground 2 – signal (+) 3 – signal (-)	Transformer balanced, Output Level is selectable using switch between Mic, -10 dB, or Line-level. For unbalanced, pin 1 and pin 3 tied together = ground, pin 2 = positive. Balanced AES3 Out A,B on XLR connectors, 110 ohm, 2 V p-p, AES3 and S/PDIF compatible with RCA adaptor.
3.5 mm RTN B		tip – signal L ring – signal R sleeve – signal ground	Mates with 3.5 mm TRS jack. Signal is unbalanced.
10-Pin Hirose F Master Output / RTN A Input		1 – L (+) output 2 – L (-) output 3 – R (+) output 4 – R (-) output 5 – R (+) return A 6 – n/c 7 – L (+) return A 8 – n/c 9 – ground 10 – ground	Mates with Hirose RM15TPD-10P(71) connector. Outputs are Transformer Balanced, output level is selectable using switch between Line, -10, or Mic level. For unbalanced connections XLR connectors should be wired, pin 1 and pin 3 tied together = ground, pin 2 = positive. Balanced AES3 Out A,B on 10-Pin connector, 110 ohm, 2 V p-p, AES3 and S/PDIF compatible with RCA adaptor.
TA3M RTN B Input or TC Input		1 – ground 2 – left signal 3 – right signal (For TC, 1 and 3 - ground, pin 2 - hot +)	Unbalanced stereo input. Used for either Return B audio input or time code input for the recorder. When time code is enabled, use RTN B 3.5 mm for RTN B audio input. Mates with Switchcraft TA3F-type connector.
TA3M L and R Outputs		1 – ground 2 – signal (+) 3 – signal (-)	Active balanced, output level is selectable in Setup Menu as Line, -10, or Mic level. For unbalanced, pin 1 = ground, pin 2 = positive, pin 3 = float (no connect). Mates with Switchcraft TA3F-type connector.
TA3M Tape Output		1 – ground 2 – Left Signal 3 – Right Signal	Unbalanced stereo output. Mates with Switchcraft TA3F-type connector.
5-Pin Mixer Link I/O		1 – HP L 2 – HP R 3 – Mix R 4 – Mix L 5 – Link detection/Ground	Used to link the 552 to Sound Devices 302, 442, 552, or MixPre Field Mixers. Mates with Sound Devices XL-TA25, XL-35, and XL-TA55 optional accessory cables. See Accessories for details.
3.5 mm Headphone		tip – signal L ring – signal R sleeve – signal ground	Mates with 3.5 mm TRS jack.
1/4-inch Female Headphone		tip – signal L ring – signal R sleeve – signal ground	Mates with 1/4-inch TRS jack.
Hirose 4-pin DC Input		1 – ground 2 – not connected 3 – not connected 4 – DC (+)	10-18 Volt DC input. Mates with Sound Devices XL-NPH and XL-WPH3 powering accessories. See Accessories for details.

Specifications

Analog Inputs

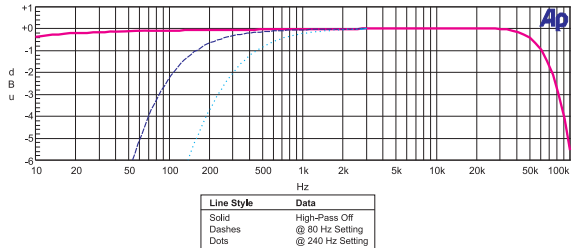
Frequency Response	20 Hz to 50 kHz, ± 0.5 dB
THD + Noise	0.09% max (50 Hz - 20 kHz, +18 dBu at line out, fader fully up)
Equivalent Input Noise	-126 dBu (-128 dBV) maximum. (22 Hz - 22 kHz bandwidth, flat filter, trim control fully up)
Input Type	XLR Mic: Transformer-balanced for use with ≤ 600 ohm mics XLR Line: Transformer-balanced for use with $\leq 2k$ ohm outputs RTN A,B (3.5 mm/TA3/10-pin): Unbalanced stereo for use with $\leq 2k$ ohm outputs Link I/O: Unbalanced stereo for linking to Sound Devices 302, 442, 552, and MixPre.
Input Impedance (ohms actual)	XLR Mic: 2k ohms XLR Line: 16k ohms RTN A,B (3.5 mm/TA3/Multi-pin): 20k ohms Link I/O: 4.2k ohms
Input Clipping Level	0 dBu minimum (trim control fully down)
Maximum Input Level	XLR Mic: 0 dBu (0.78 Vrms) XLR Line: +40 dBu (80 Vrms) RTN A,B (3.5 mm/TA3/Multi-pin): +24 dBu (12.4 Vrms) Link I/O: +6 dBu (1.5 Vrms)
Common Mode Rejection Ratio	120 dB minimum at 80 Hz, mic input 100 dB minimum at 10 kHz, mic input
High-Pass Filters	Sweepable 80 Hz to 240 Hz, 12 dB/oct at 80 Hz, 6 dB/octave at 240 Hz
	
Microphone Powering (each analog Input selectable)	Dynamic (no power applied), 12 V Phantom - through 680 ohm resistors, 10 mA per mic available, 48 V Phantom - through 6.8k resistors, 10 mA per mic available,
Input Limiters	Affects the output of the mic preamps only ('Trim' stage), +18 dBu threshold, 20:1 limiting ratio, 1 mS attack time, 500 mS release time.

Analog Outputs

Output Type	XLR Line: Transformer-balanced for use with ≥ 600 ohm inputs XLR -10: Transformer-balanced for use with $\geq 10k$ ohm inputs XLR Mic: Transformer-balanced for use with ≥ 600 ohm inputs 10-pin Hirose Line: Transformer-balanced for use with ≥ 600 ohm inputs 10-pin Hirose -10: Transformer-balanced for use with $\geq 10k$ ohm inputs 10-pin Hirose Mic: Transformer-balanced for use with ≥ 600 ohm inputs TA3 Active Balanced Mic/Line: pin-2 and 3 driven, for use with $\geq 3k$ ohm inputs TA3 Active Balanced Direct Outs Mic/Line: pin-2 and 3 driven, for use with $\geq 3k$ ohm inputs Tape Outs (3.5 mm and TA3-type): Unbalanced, stereo, for use with $\geq 6k$ ohm inputs Mono Mic Out: Unbalanced, mono, for use with ≥ 600 ohm inputs Headphones (3.5 mm and 1/4"): Unbalanced, stereo, for use with 8-2k ohm headphones
--------------------	--

Output Impedance (ohms actual)	XLR: 85 ohms at Line setting, 3.2k ohms at -10 setting, 150 ohms at Mic setting 10-pin Hirose: 85 ohms at Line setting, 3.2k ohms at -10 setting, 150 ohms at Mic setting TA3 Balanced Outs: 1k ohms at Mic and Line settings TA3 Direct Outs: 1k ohms at Mic and Line settings Tape Outs (3.5 mm and TA3-type): 1.8k ohms Mono Mic Out: 150 ohms Headphones (3.5 mm and 1/4"): 50 ohms			
Line Output Clipping Level (1% THD)	20 dBu minimum with 10k load			
Maximum Output Level	Line (XLR, 10-pin Hirose, TA3 Balanced and Direct Outs): +20 dBu (7.8 Vrms) -10 (XLR, 10-pin Hirose): +6 dBu (1.5 V rms) Mic (XLR, 10-pin Hirose, TA3 Balanced and Direct Outs): -20 dBu (0.078 Vrms) Tape Outs (3.5 mm and TA3-type): +6 dBu (1.5 Vrms) Mono Mic Out: +6 dBu (1.5 Vrms)			
Output Limiters	Affects the outputs of the mixer. Threshold selectable from +4 dBu to +20 dBu, 1 dB steps, 20:1 limiting ratio, 1 mS attack time, 500 mS release time.			
Maximum Gain Typical (Trim, Fader, Master, Phones, RTN A, RTN B fully up)		MIC Level Input	LINE Level Input	RTN A/B
	Master Outs (XLR, 10-pin, TA3) @ LINE	93 dB	53 dB	-
	Master Outs (XLR, 10-pin, TA3) @ -10	79 dB	39 dB	-
	Master Outs (XLR, 10-pin, TA3) @ MIC	53 dB	13 dB	-
	Direct Outs Post-Fade (TA3) @ LINE	87 dB	47 dB	-
	Direct Outs Post-Fader (TA3) @ -10	73 dB	33 dB	
	Direct Outs Post-Fader (TA3) @ MIC	47 dB	7 dB	-
	Direct Outs Pre-Fader (TA3) @ LINE	72 dB	32 dB	-
	Direct Outs Pre-Fader (TA3) @ -10	58 dB	18 dB	-
	Direct Outs Pre-Fader (TA3) @ MIC	32 dB	-8 dB	-
	Tape Out (TA3 and 3.5 mm)	79 dB	39 dB	6 dB
	Mono Mic Out (3.5 mm)	53 dB	13 dB	-20 dB
	Headphones (1/4" and 3.5 mm)	107 dB	67 dB	34 dB

Digital Outputs/Recorder

AES3 Output:	Transformer-balanced AES Out A,B on XLR and 10-pin Hirose connectors, 110 ohm, 2 V p-p, AES and S/PDIF compatible with RCA adaptor
Sampling Frequency	44.1, 48, 88.2, 96 kHz
A/D	24 bit, 96 kHz maximum sampling rate
A/D Dynamic Range	103 dB, A-weighted bandwidth typical
Media Type	Secure Digital High Capacity (SDHC), Secure Digital (SD) FAT32 formatted, will format media on-board
File Type	WAV - 2-Track Polyphonic, 16 bit, 24 bit MP3 - 2-Track Polyphonic, 64 kb/s, 128 kb/s, 192 kb/s, 320 kb/s fixed file name using date/time as file name, daily folders
Sampling Clock Accuracy	± 0.5ppm
Time Code	Reads external time code received and stamps BEXT/iXML header for WAV, stamps ID3 tag for MP3 Frame rates - (auto-sense) 23.976, 24, 25, 29.97DF, 29.97ND, 30DF, 30ND, 30+ Input - 20k input impedance, 0.3 V - 3.0 V p-p (-17 dBu - +3 dBu).

Power

External Power Supply	Isolated (floating) DC input jack, 10-18 V Locking 4-pin Hirose connector, pin-4 = (+), pin-1 = (-). Mates with gold Hirose #HR10A-7P-4P (DigiKey# HR110-ND) or silver Hirose #HR10-7P-4P (DigiKey# HR100-ND) locking connector.
Internal Power Supply	4-8 V range internal batteries. Accepts 4 AA-sized (LR6) batteries of various types including; Alkaline, Lithium primary, and NiMH rechargeable. There are similar sized 3+ V Lithium-cells that are not compatible.

Environmental

Operation and Storage	Operating: -20°C to 60°C, 0 to 90% relative humidity; (non-condensing) Storage: -40°C to 85°C
------------------------------	--

System

Metering	Dual 21 segment, sunlight-viewable, selectable Peak, VU, Peak + VU, or Peak + Peak Hold ballistics
-----------------	--

Dimensions and Weight

Size	53 mm x 279 mm x 168 mm (H x W x D), 2.1" x 11" x 6.6"
Weight	unpackaged: 2.0 kg, (4 lbs 6 oz.) without AA batteries

Block Diagram - Inputs and Outputs

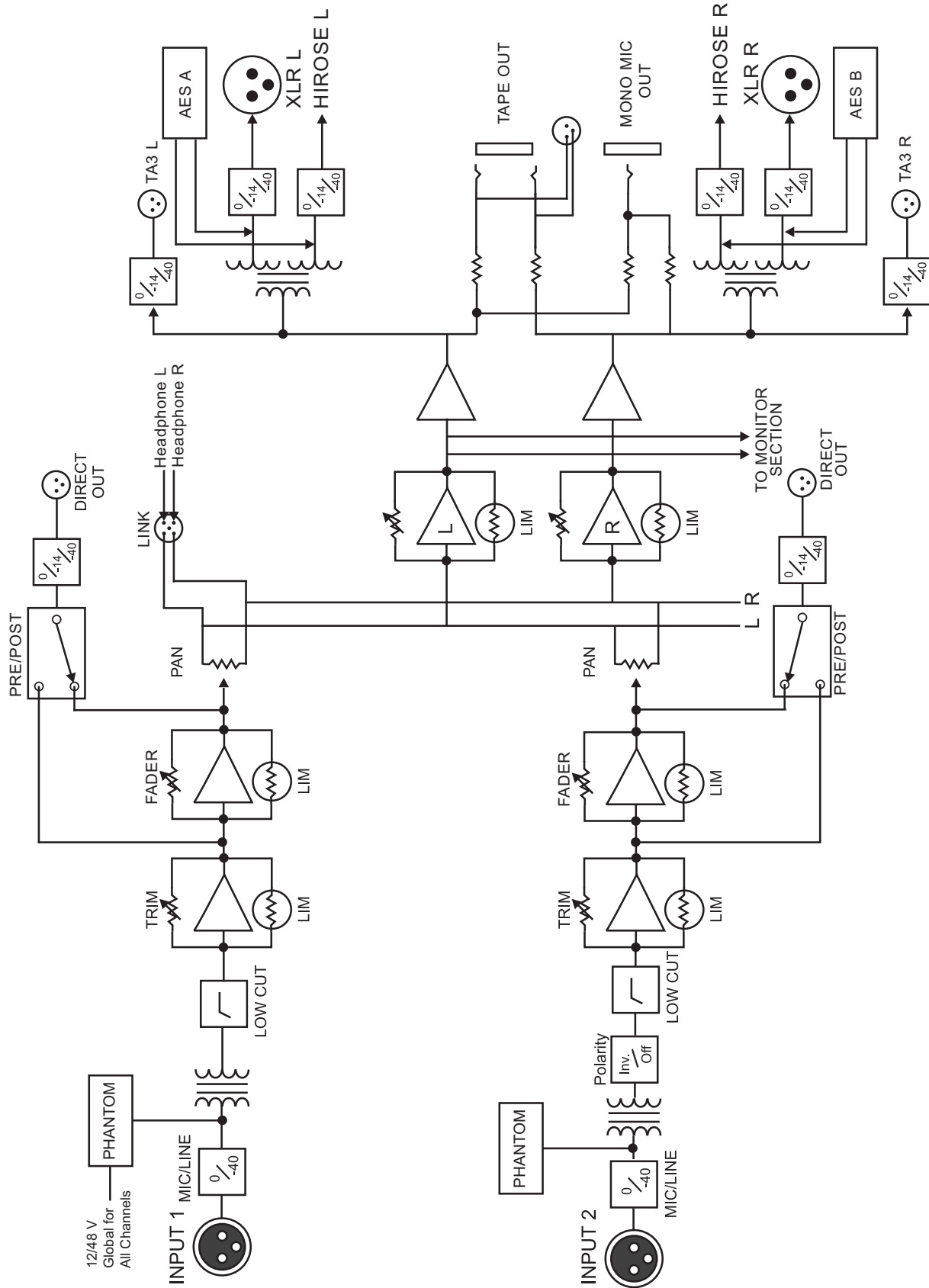

Block Diagram - Monitoring

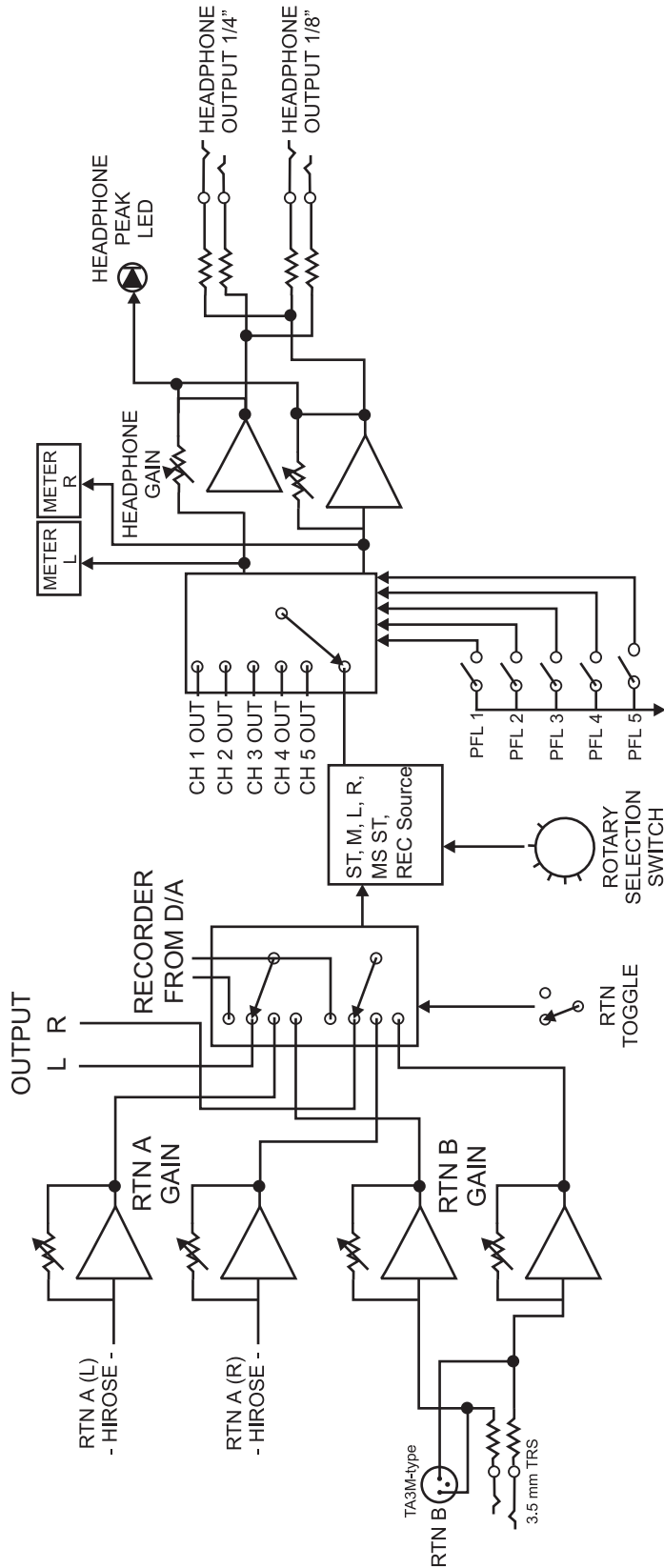



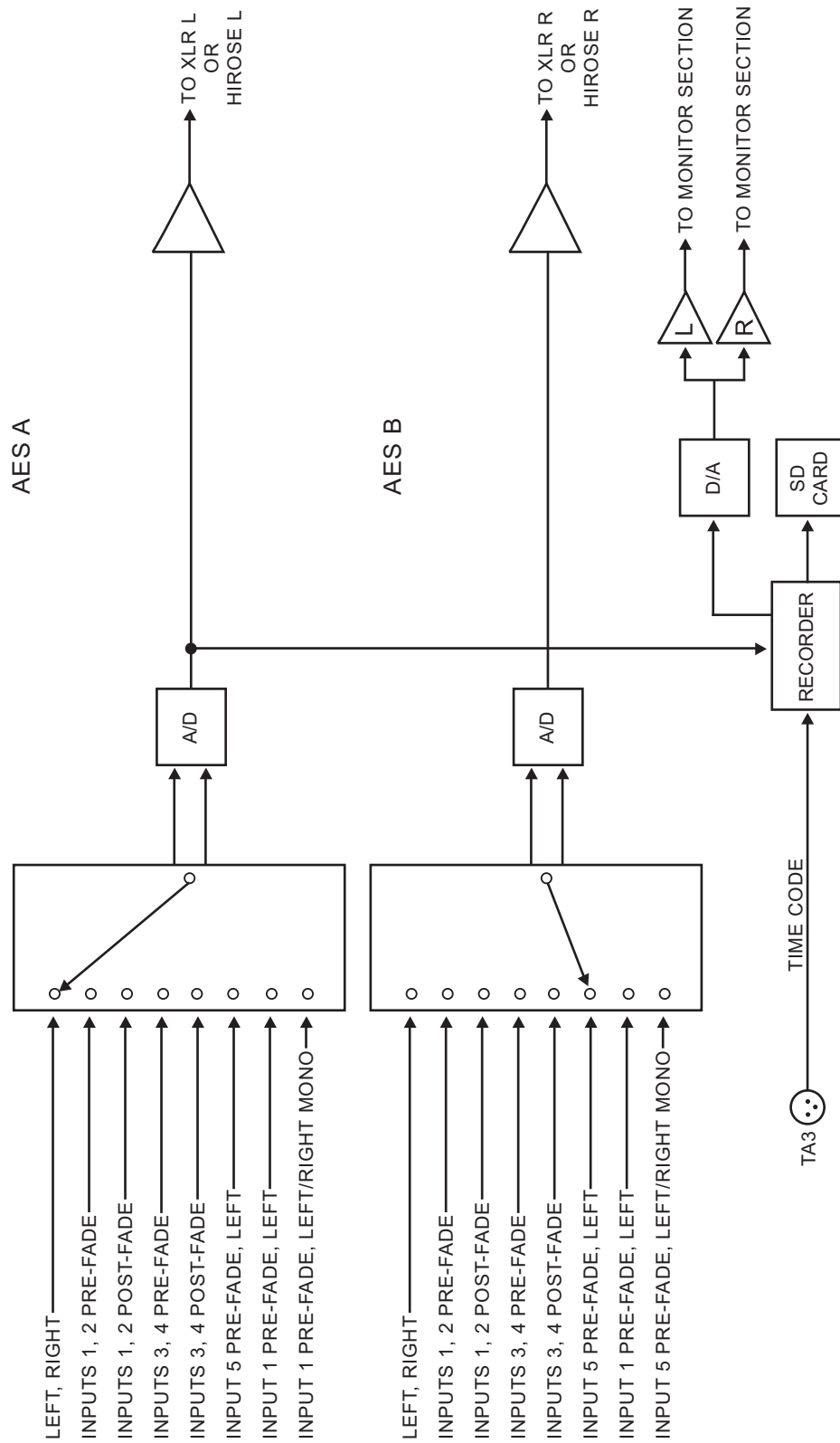

Block Diagram - AES



Accessories

Several high-value accessories are available for the 552, including production cases, cables, and power accessories. For a full list of Sound Devices products and accessories, visit our web site www.sounddevices.com/products.

Optional 552 Related Accessories

<p>CS-5</p> 	<p>Production case with high-quality strap for use with the 552 with integrated accessory compartment and NP-type battery compartment. Built for Sound Devices by CamRade.</p>
<p>CS-W</p> 	<p>Removable accessory case for the CS-5 Production Case. Designed to hold wireless transmitters and receivers. Built for Sound Devices by CamRade.</p>
<p>Wave Agent Beta</p> 	<p>Sound Devices Wave Agent file librarian for Mac OS and Windows computers. Wave Agent provides a comprehensive and indispensable range of tools for preparing audio files for problem-free passage through complex production workflows. For more details and download visit www.waveagent.com.</p>
<p>XL-1B</p>	<p>12-inch TA3F to TA3F cable, connects the 552 Direct or TA3 Master outputs to TA3 inputs of receiving devices such as the Sound Devices 788T's analog inputs 5-8. XL-1B is also used for 552 unbalanced stereo Tape Out and RTN B Input.</p>
<p>XL-2</p>	<p>25-inch TA3F to XLR-M cable, used to connect 552 Direct or TA3 Master Outputs to third-party devices with XLR-F inputs; package of two.</p>
<p>XL-2F</p>	<p>25-inch XLR-F to TA3F cable, used to connect mixers and other devices with XLR-M outputs to the 552 TA3 RTN B Input; package of two.</p>
<p>XL-4</p>	<p>Bag of four (4) TA3-F-type connectors.</p>
<p>XL-10</p>	<p>Hirose 10-pin to two-XLR (balanced L/R) and 3.5 mm plug (552 Stereo Return A) breakout cable, 24-inch; includes in-line 20-foot extension cable; 442 and 552-specific.</p>
<p>XL-H</p>	<p>Bare Hirose 4-pin locking DC connector (HR10-7P-4P).</p>
<p>XL-NPH</p> 	<p>NP-type battery cup with 24-inch cable terminated in Hirose 4-pin locking DC connector (HR10-7P-4P) at equipment end.</p>
<p>XL-TA25</p>	<p>TA5F to 3.5 mm TRS, 12-inch, used to connect 552 TA5M Link I/O to the MixPre or 442 Tape Out/Mix Out 3.5 mm jack for mixer linking.</p>
<p>XL-TA35</p>	<p>TA5F to TA3F, 12-inch, used to connect 552 TA5M Link I/O to 302 or 442 Tape Out/Mix Out TA3M connector for mixer linking.</p>
<p>XL-TA55</p>	<p>TA5F to TA5F, 12-inch, used for 552-to-552 mixer linking.</p>
<p>XL-WPH3</p> 	<p>AC to DC Power Supply (in-line) 100 - 240V 50/60 Hz input, 12 VDC 3.75 A (45 W) output, Hirose 4-pin DC plug. Supplied with 3-pin IEC cord for use in North America and Japan.</p>

Wave Agent



Wave Agent Beta is a WAV file librarian for Mac OS and Windows computers. Designed for Production Sound Mixers and Post Production Editors, Wave Agent provides a comprehensive and indispensable range of tools for preparing audio files for problem-free passage through complex production workflows.

Wave Agent is an essential, time-saving tool for anyone working in Production Sound. It allows for the following;

- Playback of polyphonic and monophonic WAV and Broadcast Wave files from any source
- Viewing and editing file metadata
- Changing of sampling rate, frame rate, and start time code metadata stamps
- Splitting and combining polyphonic and monophonic files with selectable track assignments
- Batch editing
- Generating customized PDF and CSV Sound Reports
- Large time code display
- Monitor mixer with faders, pans, solos, mutes, and meters
- Drag-and-drop operation
- Comprehensive keyboard shortcuts for accelerated operation
- Mac OS and Windows compatible

Wave Agent is available as a no-charge software download for either Mac OS or Windows.

<http://www.sounddevices.com/download/waveagent.html>

CE Declaration of Conformity

According to ISO/IEC Guide 22
 Sound Devices, LLC
 300 Wengel Drive
 Reedsburg, WI 53959 USA

declares that the product, 552 Five Channel Portable Production Mixer with Integrated Recorder is in conformity with and passes:

EN55103-1, 1997	EMC-product family standard for audio, video, audio-visual and entertainment lighting control apparatus for professional use. Part 1: Emissions
EN55103-2, 1997	EMC-product family standard for audio, video, audio-visual and entertainment lighting control apparatus for professional use. Part 2: Immunity
EN55103-1 Phenomena 2, 3, 1997	Magnetic emissions at 1 meter 50 Hz – 50 kHz
EN55103-2 Phenomena 3, 1997	Magnetic immunity 50 Hz to 10 kHz
EN61000-4-2 (2001)/ IEC61000-4-2 (2001)	ESD, ± 4 kV contact, ± 8 kV air discharge
EN61000-4-3 (2001)/ IEC1000-4-3 (2001)	Radiated RF immunity, 10 V/m, 80% 1 kHz amplitude modulation
EN61000-4-4 (2001)/ IEC61000-4-4 (2001)	AC power ports: EFT Burst, I/O lines, ± 0.25 kV to ± 1.0 kV, power line ± 0.5 kV – ± 1 kV
EN61000-4-4 (2001)/ IEC61000-4-4 (2001)	EFT Burst, I/O lines, ± 0.25 kV to ± 1.0 kV, power line ± 0.5 kV – ± 1 kV
EN61000-4-5 (2001)/ IEC61000-4-5 (2001)	Surge ± 1 kV differential mode (line-to-line), ± 2 kV common mode (line-to-ground)
EN61000-4-6 (2001)/ IEC61000-4-6 (2001)	Conducted RF immunity, 3 V, 80% @1 kHz amplitude modulation
IEC61000-4-11(2001)	Voltage dips and short interruptions at test voltage level: 0% V unominal @ 70% V unominal @ 25 period

Tested by L. S. Compliance, Inc. Cedarburg, Wisconsin
 September 6, 2009



Matthew Anderson
 Director of Engineering
 Sound Devices, LLC

Warranty and Technical Support

Warranty & Service

Sound Devices, LLC warrants the 552 Production Field Mixer against defects in materials and workmanship for a period of ONE (1) year from date of original retail purchase. This is a non-transferable warranty that extends only to the original purchaser. Sound Devices, LLC will repair or replace the product at its discretion at no charge. Warranty claims due to severe service conditions will be addressed on an individual basis. THE WARRANTY AND REMEDIES SET FORTH ABOVE ARE EXCLUSIVE. SOUND DEVICES, LLC DISCLAIMS ALL OTHER WARRANTIES, EXPRESS OR IMPLIED, INCLUDING WARRANTIES OF MERCHANTABILITY AND FITNESS FOR A PARTICULAR PURPOSE. SOUND DEVICES, LLC IS NOT RESPONSIBLE FOR SPECIAL, INCIDENTAL, OR CONSEQUENTIAL DAMAGES ARISING FROM ANY BREACH OF WARRANTY OR UNDER ANY OTHER LEGAL THEORY. Because some jurisdictions do not permit the exclusion or limitations set forth above, they may not apply in all cases.

For all service, including warranty repair, please **contact Sound Devices for an RMA** (return merchandise authorization) before sending your unit in for repair. Product returned without an RMA number may experience delays in repair. When sending a unit for repair, *please do not include accessories, including SD cards, batteries, power supplies, carry cases, cables, or adapters unless instructed by Sound Devices.*

Sound Devices, LLC
Service Repair RMA #XXXXX
300 Wengel Drive
Reedsburg, WI 53959 USA
telephone: (608) 524-0625

Technical Support / Bug Reports

For technical support and bug reporting on all Sound Devices products contact:

Sound Devices, LLC
E-mail: support@sounddevices.com
web: www.sounddevices.com/contact_support.htm
Telephone: +1 (608) 524-0625 / Toll-Free in the U.S.A.: (800) 505-0625
Fax: +1 (608) 524-0655

Sound Devices cannot guarantee that a given computer, software, or operating system configuration can be used satisfactorily with 552 generated files based exclusively on the fact that it meets our minimum system requirements.

Please check with your software editing application to make certain that it is compatible with the file type selected

SOUND **DEVICES**